



Instruction Manual

REFRIGERATOR-FREEZER

**MODEL: BAFF515SS
BAFF515BK**

Warning



Caution: risk of fire (R600a)

Warning: connect to potable water supply only.

when the foods need be fast frozen, you'd better make the foods cold first. Set the freezer's temp at -24°C . control position to the quick freezer, then put the fresh foods.

Data

Rated Power(W)	118
Size(width/depth/height):mm ----- Net	902x750x1760
Net weight	112
Rated temperature rise(min)	350
Overall space required in use(mm)	W1566 * H 1760 * D 1055

Ice-maker uninstall and install

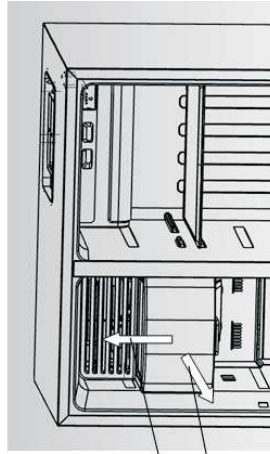

① ②

Uninstall

Lift the ice-maker up in the ① direction, and pull it out in the direction ②, then take it out.

Install

Install the ice-maker, push it to the end in the ① direction.

Description of all components

Some features and components of the refrigerator you bought may not be exactly the same as the legend here, but in accordance with the packing list in the refrigerator. Sorry to any trouble to you.

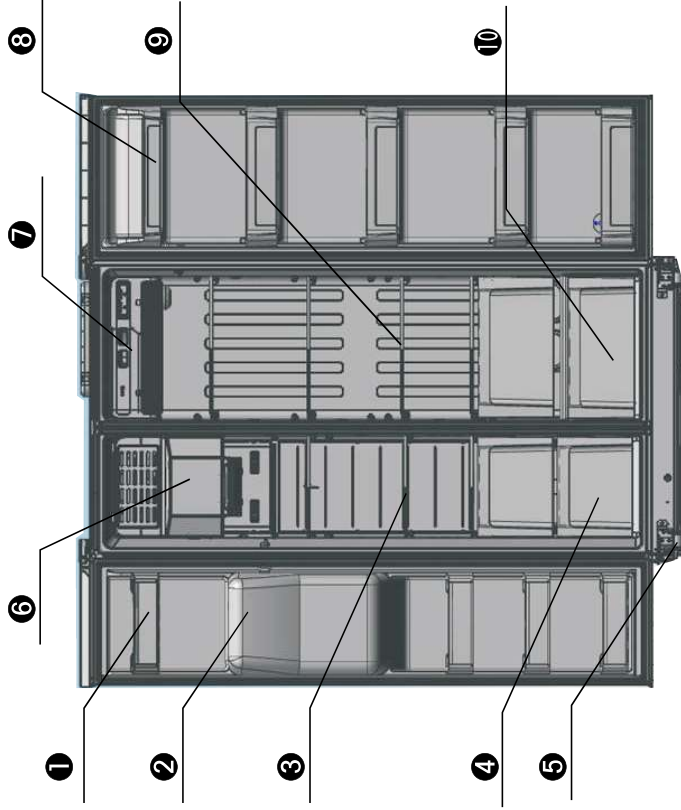

- ① Freezer Door Tray
- ② Ice outlet
- ③ Freezer Shelf
- ④ Freezer Drawer
- ⑤ Pulley
- ⑥ Ice Maker
- ⑦ Refrigerator Lamp
- ⑧ Refrigerator Door Tray
- ⑨ Refrigerator Shelf
- ⑩ Crisper



Features

- **Constant-temperature preservation technology**
The freezer has a specific air delivery and circulation system. It can control temperature separately, so that the storage temperature is stable and foods can be saved longer.
- **Pre-cooling before defrosting**
It can judge the temperature in the refrigerator before defrosting and do precooling to benefit the preserving of the foods with little temperature change in the refrigerator before and after defrosting.
- **Intelligent defrost**
According to actual use frequency and frosting speed, the intelligent defrost is adopted to save energy.
- **Ultrathin, supergreat and luxury design**
It has ultrathin size, super great volume, and large refrigerator and freezer capabilities. The refrigerator is made of high-grade tempered glass shelf and provided with a large fruits and vegetables chamber.
- Fluorine-free, frost-free and full air-cooled refrigeration system provides quick cryogenic refrigeration and quick freezing.
- Function of automatic default display.
- It is provided with a condensing unit and a fan for heat emission, so that cooling effect is preferable and the life span of the compressor is long.
- Door alarm.

● The advised storage area for various foods in the refrigerator (see the Diagram on P1)

- **The glass shelf of the refrigerator:** flour-based foods, can, milk, fast food, dairy products, cooked meat, sausage and so on.
- **Crisper:** fruits, vegetables and so on.
- **Storage box:** eggs, butter, cheese and so on.
- **Refrigerator door tray:** tear-off tins, cans, condiment, drinks and various bottled foods.

Freezer

The temperature in the freezer is very low, so that the foods can be stored freshly for a long time. Therefore, you had better to put the food to be stored long in this place. But, the storage time on the food package must be observed.

● The advised storage area for various foods in the freezer (see the Diagram on P1)

- Freezer door tray (two star level) is used for short-term reservation of food.
- Freezer door tray is used to reserve frozen food.
- Freezer glass shelf is used to reserve frozen food, such as fish, meat, ice cream and so on.
- The ice maker is used to make ice.
- Freezer drawer is used to reserve fish, meat and packaged poultry meat.

Warning

- Except the manners recommended by the manufacturer, no other equipment and manners can be used to speed up the process of defrost.
- Except the types recommended by the manufacturer, no other electric appliances can be used in the food refrigerator.
- R600a refrigerant and cyclopentane foam materials used in CE-BCD515WE-S are flammable. The waste refrigeratories need to be isolated from fire and cannot be burnt.

The coming of new refrigerator

- Before the use of the refrigerator, remove all packages, including bottom cushion and foam pads and rubber belts in the refrigerator;
- Clear the outside and inside of the refrigerator with a piece of warm wet rag (little detergent can be added into the warm water. Clear the refrigerator with fresh water at last);
- Prepare a separate two-pole grounding receptacle.
- Do not share a multi-socket with other electric appliances.

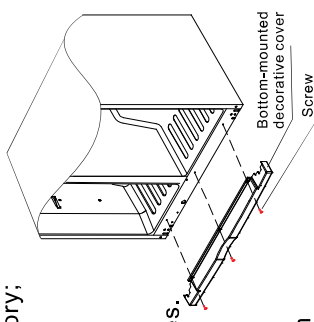

- The ground wire must be well connected and the grounding pole of the receptacle should be grounded reliably.
- Open the door, take out the attachments (the bottom decorative cover), and three setscrews in the bag of the Instruction. And install it onto the bottom beam of the refrigerator. For operation method, see the right diagram.

Transport and placement of refrigerator

Transport

- Do not invert, place horizontally, squeeze or shock the refrigerator. And the declination angle of the refrigerator must be no more than 45 when moving.
- When moving, do not force too much on the door or top for fear of deformation.

Placement

- Place the refrigerator at a well-ventilated place and keep it away from heat and direct sunshine. Never put it at a damp or watery place, for fear of rusting or weakening the insulation.
- The top clearance outside the refrigerator must be no less than 30cm, and the clearance from both sides and back to the walls must be no less than 10cm for the convenience of opening and heat emission.
- Put the refrigerator on the flat and solid ground. (adjust the adjustable legs to get balance if unstable).
- **Standing**
Do not switch on the refrigerator immediately after vertical placement. Only switch it on after 6 hours' standing to ensure its proper operation.

Notice

To prevent damage to the power cord and any consequent incidents, the power cord should not be covered by the refrigerator or other objects. Before switching on the refrigerator, please check carefully whether the voltage

Proper use of refrigerator

Begin to use

Make sure the refrigerator is located properly and stably and understand all safety considerations.

After unsealing the refrigerator, to fix lower cover on the refrigerator

(if the door rugged, Please refer to the adjustment instructions which locate in the lower left corner of the right panel of Refrigerator to adjust.)

1. Unpacking (if the door height is uneven, adjust it according to the adjustment instruction at the lower left corner of the refrigerator's right side plate)

After unpacking, install the bottom decoration cover onto the refrigerator.

2. Switch-on

When switching-on, the refrigerator enters the state of factory settings automatically. This refrigerator has the power-down memory function. After the first switch-on, the refrigerator will operate as per the settings at last power-down.

3. Put foods into refrigerating.

After electrifying and operation for a period of time (about 3-5 hours in summer), the inner side of the refrigerator is fully cool. Then, foods can be put in and the refrigerator can be used formally.

Tips: after the temperature setting has been changed or new food has been put in, the inner temperature of the refrigerator can reach a balance after a period of time. And the length of the period is determined by the changing of temperature setting, ambient temperature, opening frequency, amount of food in the refrigerator, etc.

Refrigerator

Though most places in the refrigerator can be kept at 2-8°C averagely by adjusting temperature setting, the food in the refrigerator cannot keep fresh for a long time. Therefore, the refrigerator can only serve to store food in short term.

Adjustment of shelf

According to the need of the food to be stored, the shelf can be adjusted to a proper height.

To ease the use or adjustment of the glass shelf, it is designed for sliding; when cleaning the glass shelf, please pull the glass shelf in the direction ① and whirl it in the direction ② at the same time until it is perpendicular to the original position, and then take it out at 90° in the direction ③.

Adjustment and cleaning of door tray

Hold two sides of the tray, lift it up in the ① direction, and pull it out in the direction ②.

After cleaning, install the tray in opposite directions.

The installation place can be adjusted according to the height of the food.

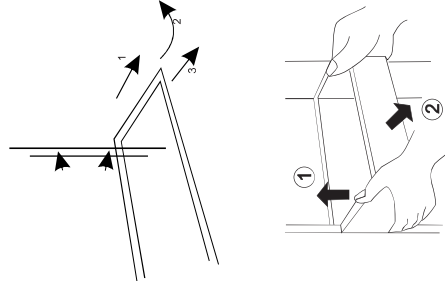

Proper use of refrigerator

Operation and precautions for ice maker

Warning: connect to potable water supply only.

Connection of water pipes: please contact the after-sales Service Department of the Company or professionals to install to avoid any risk.

Notice

Before operating the automatic ice-making system, please take down the seal box in order to make the system works fluently.

When shut down the automatic ice-making system, please seal up the seal box in order to keep the system more energy-efficient.

<Connection of water pipes>

Warning!

The water pipes must be connected under the condition of power-off. Electric shock may cause serious injury or death.

Notices!

The water pipe cannot be used where environmental temperature is under 0°C. Or it may lead to freezing.

The water pipe cannot be connected to hot water, which may lead to deformation.

The water pipe should be used in the pressure range 30-100psi.

Lower pressure may cause smaller ice pieces and longer water exiting time.

But higher pressure may damage the filter.

The pipe cannot be connected to drinks, alcohol or other liquids except for water.

1. Turn off the water-tap.

2. Connect water pipe onto the water-tap. The water pipe should be long enough to prevent the drop-off of the water pipe caused by removing of refrigerator.

3. Turn off the refrigerator.

4. Use a connecting pipe to connect the water pipes behind the refrigerator and on the water-tap.

5. To prevent the drop-off or leaking of the water pipes, they must be fixed by fixed pins.

6. Turn on the water tap to check leakage.

7. The refrigerator is energized an used normally.

<Use of Automatic Ice Maker/ Ice & Water Dispenser>

Notices!

The water pipes are used in the pressure range of 30-100psi.

Water softeners may damage the ice maker and must not be used.

Please check the ice pieces in the storage box when power-off above 1h. If the ice pieces are

thawing and binding together, please empty them. Because the bound ice pieces may cause Failure of the ice system.

When the ice pieces in the storage box are binding together, you had better to melt it with warm

water rather than smash and take out them with a sharp tool, which may damage the

refrigerator.

A. Supply of cold water

1. Choose the ice/water button on the display board, and make sure the water indicator turns on.

2. When the water switch plate is pressed by the cup, the cold water comes out.

3. When using the refrigerator the first time, water does not come out before the water tank in the refrigerator is filled up. The normal manner to get water is pushing and holding the switch plate for 2-3 minutes.

4. After the water comes out, please discharge water for about 3 minutes to purge the air and smell of plastic in the water pipe.

5. When cold water is required, it's better to get some ice before getting water.

6. When getting water, it is normal for noise of valve operation.

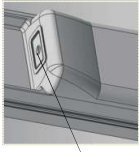

Seal box



Ice maker

A. Operation of automatic ice maker

1. Automatic ice maker operates when the freezer reaches the needed temperature below 0° after a period prescriptive time when the refrigerator is energized. Under normal temperature, the time between the refrigerator's first energizing and first making of ice is about 6 hours.
2. The ice firstly made after the installation of the refrigerator shall be thrown away because of plastic smell and impurities.
3. The time interval of ice making is about 2 hours, and the amount of the ice is different according to different service conditions.
4. When the ice storage is full, the ice maker will stop automatically, and when the ice storage is empty, the ice maker will make ice again automatically.
5. The noises for de-icing, motor operation, dropping of ice into the ice storage, and operation of water supply valve may not happen periodically. They are not errors.
6. Please use the button on/off on the distributor to turn off the ice-making function when it is not required. The ice maker is sold under ON state. If unnecessary, please turn off this function timely after installation of the refrigerator. When the ice-making function is turned on without connection of waterways, there are operational noises of water supply valve.
7. When ice piece is smaller than usual in a certain period of time, please verify the replacement frequency of the filter. When the filter reaches its operation time, the water supply pressure is lower and the made ice piece is smaller.
8. When cleaning the ice storage box, turn off the ice-making function on the distributor before detaching the ice storage box.
9. Do not whirl the Auger during reinstallation of the removed ice storage box. After being whirled, the Auger cannot be assembled and installed normally. It may be damaged when taking out the ice. Whirl the Auger left and right after it has been whirled to ensure normal installation.

B. Supply of ice

1. Choose the ice/ water button on the display board, select entire or crushed ice pieces and make sure the relevant indicator turns on.
2. Use the container to push and hold the switch plate to get ice.
3. According to the water supply condition, some mixed small ice pieces may come out when getting the entire ice pieces..
4. When crushed ice pieces are required, please press the container most close to the ice discharging orifice to prevent the crushed ice from dropping out.
5. When getting ice, the noises of motor, crushing ice and so on are normal.
6. To protect the motor, the refrigerator will stop when the switch plate is pushed for 1 minute or more. Then, releasing the switch plate and waiting a moment, you can get ice normally again. When large amount of entire ice pieces are required, please open the door Of freezer, take the ice storage box out and use the ice in it.

[Way to replace the filter]

1. The filter installed in this refrigerator is refined by NSF42, which can filter the smell, chlorine and so on in running water.
2. The replacement cycle of the filter is about 6 months. When replacement is needed, the indicator on the display board will turn on. The replacement cycle may be shortened according to operating environment.
3. With the function of BY-PASS, it can supply water normally without the filter. If necessary, additional filter can be installed and used out of the refrigerator by yourself.
4. During replacement, little water in the connection part may drop out, a container can be located under it to receive the drops.
5. The filter is installed in the liner of the refrigerator. You can seize the lower bugle and whirl it leftward to take it out. When it is difficult to take out, you can detach the lampshade in the refrigerator before detaching the filter.
6. The assembling is in opposite order. Push it upwards and whirl it rightward at the same time.

Operating instruction for the display and control panel

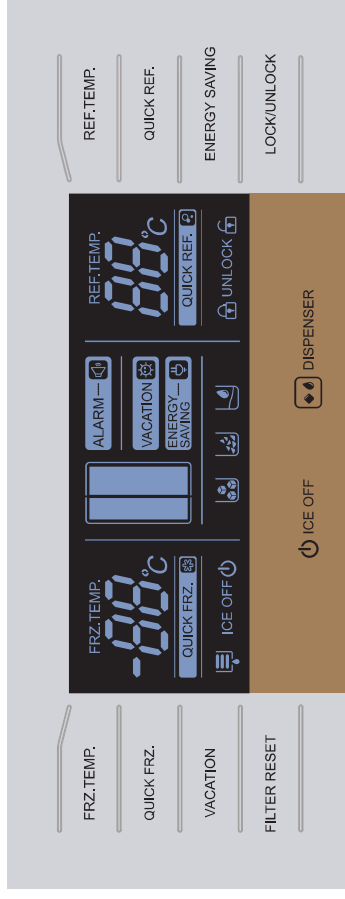

Button setting

When power-on, the refrigerator will operate in the intelligent mode. The system automatically sets the refrigerator temperature at 5°C, and that of the freezer at -18°C.

Refrigerator temperature setting

Function:

- A. Set the temperature of the refrigerator in the following range: 02°C-08°C. 1°C changes every time of pushing.
- B. Achieve the turn-on and turn-off of the refrigerator.

Operation:

Temperature adjusting: push the button “REF.TEMP.”, and the icon of the refrigerator flashes. And push the button once again, to adjust the temperature (the cycle of the adjustment order is 08-02-08), and the setting comes into effect after 5 seconds.

Proper use of refrigerator

Turning off the refrigerator: when the refrigerator is under the ON state, push and hold the button “REF.TEMP.” for 3 seconds, the refrigerator is turned off with a beep. When the refrigerator is under the ON state, push and hold the button “REF.TEMP.” for 3 seconds, the refrigerator is turned on with a beep. Adjust the temperature to cancel the function of turn-off.

When closing the refrigerator, the icon of the refrigerator turns on. The double 8 shows “-” , and the relevant icon of the refrigeratory turns off.

Freezer temperature setting

Function:

Set the temperature of the freezer in the following range: -16℃ - -24℃. 1℃ changes every time of pushing.

Operation:

Temperature adjusting: push the button “FRZ.TEMP.” once, and the icon of the freezer flashes. Push the button again to adjust temperature. (The cycle of the adjustment order is the present temperature- -16- ... -24- -16) The setting comes into effect after 5 seconds of temperature adjusting.

Vacation mode

Push the button “VACATION” , “VACATION” icon turn on, to enter the vacation mode. Push this button again to exit this mode.

The system can close the refrigerator automatically. The refrigerator temperature is set at -15℃. The closed compartments will not cool. The cooling compartments will operate at the set temperature.

Energy-saving mode

In the mode of energy saving, the refrigerator and freezer operate at the set temperature Trs= 7℃ and Trs= -15℃ respectively.

QUICK REF.: push this button, and the indicator of quick cooling flashes, which indicates the quick-cooling mode. The relevant icons and words flash. Push the unlock button to confirm it.

QUICK FRZ.: push this button, and the indicator of quick-freeze flashes, which indicates the quick-freeze mode. The relevant icons and words flash. Push the unlock button to confirm it.

Push the button “QUICK FRZ” again when the quick-freeze icon flashes, the quick-freeze time shown by the freezer changes in the cycle of 6h-8h-12h-24h-48h-exit the quick-freeze mode. Push the button of “LOCK/UNLOCK” to confirm it and the flash stops.

Proper use of refrigerator

Quick FRZ. function is a design aim to maintain the nutritional value of frozen food. It can be thoroughly frozen food in the shortest time. If you need frozen a lot of food in one time, we recommend setting fast freezing feature 12h in advance, so the freezer could turn to a low temperature, and then put into the food. At that time, the freezing capability speed up in freezer, frozen foods quickly and effectively lock the foods' nutrition.

Unlock

Under the lock state, push and hold the button “ LOCK/UNLOCK” for 3 seconds, the display panel unlocks. If time is less than 3 seconds the unlock icon flashes, which means unlock failed.

Under the unlock state, push and hold the button “ LOCK/UNLOCK” for 3 seconds, it will be locked manually, and the lock icon turns on.

Every time the operation button is pushed, it sets off a beep. Do not push any button after continuous 60 seconds, it will be locked automatically, and the lock icon turns on.

All operations (except the ice-water selector key and the filter reset key) under the unlock state are available. Under the lock state, the lock icons flash with beep alarm when pushing other buttons.

Switch key of ice maker

Choose the switch key of ice maker, push to start ice-making function until the ice storage box is full, after taking icecube, the ice storage will be filled automatically, and push this button again to cancel the ice-making function.

Key of ice water choosing: (available in the key lock state) push this button and get water, ice, crushed ice according to the following cycle.

Get water ---- get crushed ice ---- get ice

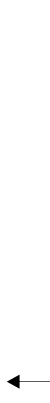

Reset of the filter

Push and hold the filter reset button for 3 seconds to reset the filter.

Memory of the first energized state after power-down

The controller has the function of power-down memory.

Memory contents:

Mode (quick-freeze time and quick cool time will be retimed after power-up)

The setting temperature of refrigerator and freezer

Accumulation time of defrost (time accuracy: 1h) (if the temperature of the defrost sensor > 2℃, the defrost time accuracy is 0.)

The first power-up state: the default state (setting temperature: refrigerator 5℃/ Freezer-18℃) (the factory state of the controller)

Cleaning

Clean the dust on the back of the refrigerator and the floor regularly. Clean the inner side of the refrigerator usually to prevent peculiar smell. Please unplug the power cord during cleaning. Use soft towel and neutral detergent, and clean it with fresh water at last.

- Please do not use the following objects to clean the inner side of the refrigerator:
- Alkaline or strongly alkaline detergent (may make the liner and plastic components cracked);
 - Soap powder, benzine, banana oil, spirit and so on (may damage the plastic components);
 - Please erase timely stain oil and condiment (may make the plastic components cracked).

Lamp and its replacement

The parameters of the lamps of refrigerator, freezer and distributor and the replacement lamps are direct current (DC) 12V, LED. When the lamps are replaced:

- Unplug the plug to cut off the power.
- Push and remove the lampshade according to the direction in the attached drawing. Remove the screws and the LED lamp.
- Reassemble them in the opposite process.
- Replacement should be done by a professional.

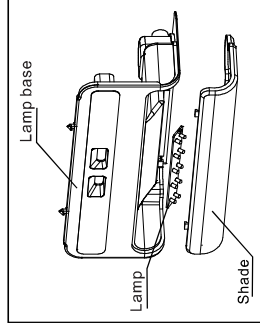

Freezer lamp

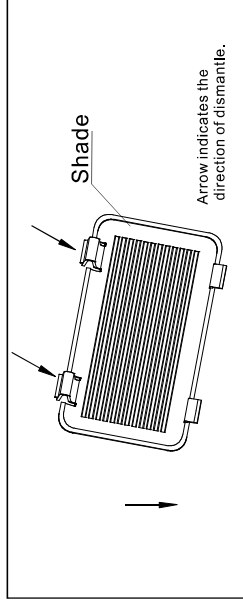
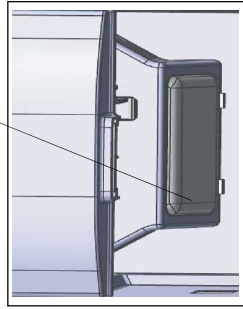

Downtime

When the refrigerator is not used for a long time,

- Turn off the power to prevent electric shock and accidents caused by aging power cord.
- Clean the inner side of the refrigerator.
- Open the door for a time, and close it with a small gap after the inner side of the refrigerator is dry to prevent bad smell.

Power-off

- Reduce the opening times as much as possible. You had better not to put fresh food into the refrigerator.

Discard

- Remove the door of the refrigerator when the waste one is discarded to prevent the accident that the child is stranded in the refrigerator.

Announcements

- the refrigerator use alternating current supply which is 220V-240V, 50Hz. If the voltage fluctuations is large(Over the scope of 187-264V), it may cause some failures,such as the refrigerator does not start, The main control board and compressor burn and the compressor works with abnormal voice. etc.At this time you must install an automatic voltage regulator which is above 1000w for use. The refrigerator's power cord with a three-plug (grounding)complies with the standard three-socket (grounding).Don't cut off or remove the third pin of the power card under any circumstances. After the refrigerator is installed, Plugs should be able to reach to facilitate use. the power Plug must be firmly contacted with the socket, otherwise it might cause fire.
- Do not grasp and drag the power cord to pull out the refrigerator plugs.Hold the plug firmly, and pull out the plug from the socket directly. Do not let power lines are pined by the refrigerator or trampled by people. Be careful when the refrigerator will be removed from walls. Do not roll or damage power lines, Do not use power lines and plugs When they were damaged or worn out. Go to the service center which the factory assigns to replace power lines if they were worn out or damaged.
- When inflammable gas is leaked, such as coal gas,close the gas valve,Open the doors and windows, Do not pull out or plug in plugs of the refrigerator and other appliances.
- Do not put flammable and explosive materials into refrigerator, such as butane, alcohol, gasoline, etc. Do not put bottled liquid products into the freezer, so as to avoid the bottles crack as a result of freezing.
- Do not use flammable solvent near refrigerator, so as to avoid fire.
- To ensure safety, do not place power outlets, voltage regulated power supply, microwave ovens and other appliances on refrigerator table.Do not use other appliances in refrigerator(except recommended models), In order to avoid electromagnetic interference and other accidents.
- Do not let children go into the refrigerator or climb up the refrigerator.In order to avoid the children are closed in it or the refrigerator falls to hurt children.
- After the refrigerator is running, Do not touch the icy surface of the freezer with hands, particularly hands are wet, It may cause frostbite.
- The gap between door and door and the gap between door and refrigerator body are very narrow.Be careful not to stretch hands into these areas to prevent fingers from injuring.Do not let the children near the refrigerator when open and close the doors.
- Do not spray and rinse the refrigerator with water, and do not install the refrigerator in the wet place or the place which water or rain splashes, so as not to affect the electrical insulation of the refrigerator.

- Never dismantle refrigerator personally, never transform refrigerator and damage cooling pipes. Maintenance of refrigerator must be carried out by professionals
 - Do not put bottled of beer、 drinks in the freezer.It may freeze the contents to break the bottle .
 - Pull out the plug when power failure or cleaning. Wait for 5 minutes or longer when reconnecting the plug.It may damage the compressor due to continuous start .
 - Before you dispose your old refrigerator,take off the door, remove the door seals and the shelves,place the door and rack in the right position ,so as to avoid the children climb inside to cause accidents.
 - This product is for household refrigerator,according to the regulation of government standard, Household refrigerators are only for food storage, not for other uses, such as storage of blood, drugs and biological products.
- This appliance is not intended for use by persons (including children) with reduced physical, sensory or mental capabilities, or lack of experience and knowledge, unless they have been given supervision or instruction concerning use of the appliance by a person responsible for their safety.

Children should be supervised to ensure that they do not play with the appliance.

If the supply cord is damaged, it must be replaced by the manufacturer, its service agent or similarly qualified persons in order to avoid a hazard.

- **WARNING:** Keep ventilation openings, in the appliance enclosure or in the built-in structure, clear of obstruction.
- **WARNING:** Do not use mechanical devices or other means to accelerate the defrosting process, other than those recommended by the manufacturer.
- **WARNING:** Do not damage the refrigerant circuit.
- **WARNING:** Do not use electrical appliances inside the food storage compartments of the appliance, unless they are of the type recommended by the manufacturer.

Do not store explosive substances such as aerosol cans with a flammable propellant in this appliance.

This appliance is intended to be used in household and similar applications such as

- staff kitchen areas in shops, offices and other working environments;
- farm houses and by clients in hotels, motels and other residential type environments;
- bed and breakfast type environments;
- catering and similar non-retail applications.

Please read the following contents carefully before repair request

Occurrence	Possible cause/inspection items
not working	Make sure power supply connecting and Plug is tightly put into outlet Check the voltage (too low),call local electrical company
not perfectly cooling	temperature be adjusted too high (make it lower) too much food stored hot or warm food stored recently doors are opened too frequently or too long heat source nearby
too much noise	plain floor or refrigerator be placed firmly check the appurtenance putting the right location
food be frozen	if it is laid near the wind way
Orders	smelling food should be packed rigorously corrupt food inner cabinet needs cleaning

If the situation seems not be better after the above items been checked, please contact our after-sale service. If the power cable is damaged, the repair must be done by the engineers sent by us for avoiding any danger..

Non-malfunction Phenomenon

The flowing speed of the refrigerant in the capillary is very high, sometime alveoli been intermixed. Hence some irregular noise may happen at the exit.

When humidity too high, surroundings of the refrigerator door may be a little wet,please wipe by a dry cloth.

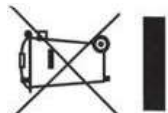
 <p data-bbox="122 1836 151 2172">Correct Disposal of this product</p> <p data-bbox="159 1724 183 2038">Correct Disposal of this product</p> <p data-bbox="215 1321 414 2038">This marking indicates that this product should not be disposed with other household wastes throughout the EU. To prevent possible harm to the environment or human health from uncontrolled waste disposal, recycle it responsibly to promote the sustainable reuse of material resources. To return your used device, please use the return and collection systems or contact the retailer where the product was purchased. They can take this product for environmental safe recycling.</p>
--

Energy Saving Tips

- The appliance should be located in the coolest area of the room, away from heat producing appliances or heating ducts, and out of the direct sunlight.
- Let hot foods cool to room temperature before placing in the appliance. Overloading the appliance forces the compressor to run longer. Foods that freeze too slowly may lose quality, or spoil.
- Be sure to wrap foods properly, and wipe containers dry before placing them in the appliance. This cuts down on frost build-up inside the appliance.
- Appliance storage bin should not be lined with aluminum foil, wax paper, or paper toweling. Liners interfere with cold air circulation, making the appliance less efficient.
- Organize and label food to reduce door openings and extended searches. Remove as many items as needed at one time, and close the door as soon as possible.