



Instruction Manual

REFRIGERATOR-FREEZER

MODEL:BAFF537SS

BAFF537BK

Warning



Caution:risk of fire

Warning:connect to potable water supply only.

**when the foods need be fast frozen,you' d better make the foods cold first.
Set the freezer' s temp at -24°C control position to the quick freezer,
then put the fresh foods.**

Please read it carefully and keep for future reference

NOTICE

Before it is used, please notice important safety instruction

Please read this guide thoroughly before operation and keep it handy for reference at all time.

The company's products should continue to improve, subject to change without notice,

When disposing of any refrigerator equipment please contact your local waste disposal department for advice on safe disposal.

This appliance is intended to be used in household and similar applications such as

- staff kitchen areas in shops, offices and other working environments;
- farm houses and by clients in hotels, motels and other residential type environments;
- bed and breakfast type environments;
- catering and similar non-retail applications.

When the fresh food need to be quick freezing, you may:

For this model, set the mode at the quick-freeze, then put the fresh food into the freezer.

You purchase refrigerator certain characteristics and fitting possibly with this using guide not completely consistent, Please take the refrigerator in the packing list as the standard. This makes an apology sincerely.

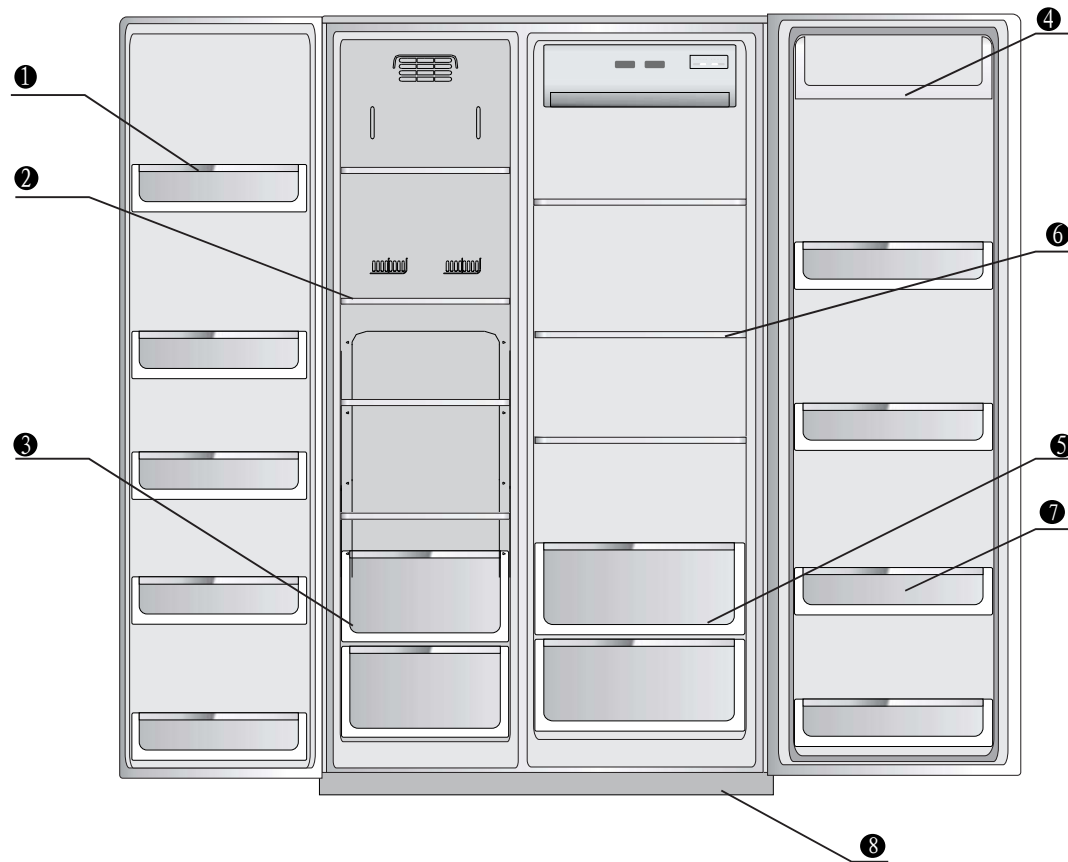

1 Freezer door rack

5 Vegetable crisper

- 2 Freezer compartment glass shelf
- 3 Freezer compartment drawer
- 4 Substance box

- 6 Refrigerator compartment glass shelf
- 7 Refrigerator door rack
- 8 Lower cover

Preparing before using

Sepecification of product

- **Invariable keeping fresh technology**

Separate windy system in refrigerator compartment, separate temperature control, stable storage temperature, long time fresh.

- **Defrost pre-cold**

Technology of defrost pre-cold with purpose of keeping temperature stable in refrigerator, suitable for keep food fresh.

- **Aptitude defrosting**

Defrosting depends on using frequency with purpose of energy saving

- **VIP anti-heat technology**

Thick foaming in anti-heat layer, low energy consumption

- **Gliding shelves, convenient using**

Freezer and refrigerator's rack designed as gliding and stretching ,it's convenient to stored.

- **Human aptitude**

Freezing effect is adjusted according to storage temperature and inside temperature by computer

- **Nice dimension**

Ultra-thin size;Ultra great volume; Refrigerator compartment uses the upscale armored glass rack.

- **CFC and no-frost design. Fasting freezing**

- **Automatic alarm of problem**

- **Reliable compressor with good quality**

- **Opening door alalrm, LED screen**

- **Vitamins fresh technology**

Warning

- 1) **WARNING**– Keep ventilation openings, in the appliance enclosure or in the built-in structure, clear of obstruction.
- 2) **WARNING**– Do not use mechanical devices or other means to accelerate the defrosting process, other than those recommended by the manufacturer.
- 3) **WARNING**– Do not damage the refrigerant circuit.

- 4) **WARNING**– Do not use electrical appliances inside the food storage compartments of the appliance, unless they are of the type recommended by the manufacturer;
- 5) The appliance has to be unplugged after use and before carrying out user maintenance on the appliance.
- 6) This appliance is not intended for use by persons (including children) with reduced physical, sensory or mental capabilities, or lack of experience and knowledge, unless they have been given supervision or instruction concerning use of the appliance by a person responsible for their safety.
- 7) Children should be supervised to ensure that they do not play with the appliance.
- 8) If the supply cord is damaged, it must be replaced by the manufacturer, its service agent or similarly qualified persons in order to avoid a hazard.
- 9) Please handle and abandon the refrigerator according to local regulations for its use flammable blowing gas and refrigerant.
- 10) Do not store explosive substances such as aerosol cans with flammable propellant in this appliance.

Correct Use for Your Refrigerator

Warnings

- Don't use mechanical equipment or other methods to accelerate the defrosting process except the means recommended by the manufacturer.
- Don't use any electrical appliances in the food storage compartments except the model recommended by the manufacture.
- The R600a refrigerant and cyclopentane foaming material used in the refrigerator are inflammable. All waste and discarded refrigerators shall be placed away from naked fire and they are not allowed to burn.

New refrigerator is coming

- Remove all packaging material before using the new refrigerator. This includes the foam base and all adhesive tape holding the refrigerator accessories inside and outside.
- Clean both the inside and outside of the refrigerator with wet cloth (a little detergent could be added into the warm water to wash the cloth and then wipe it again with the clean water);
- Prepare an independent two-pole socket with grounding contact for the refrigerator and it shall not share a multi-purpose socket with other electrical appliances;
- Do connect grounding wire! The grounding pole of the socket shall be provided with a reliable grounding wire.
- Open the refrigerator body and take out the accessory (decorative cover for bottom beam) and the three screws from the instruction packaging bag; then install them into the bottom beam as shown by the schematic diagram on the right.

Note: The decorative cover for bottom beam is used as ornament, so you can choose not to install it. It won't affect the refrigerator's performance or conditions no matter whether you install it or not.

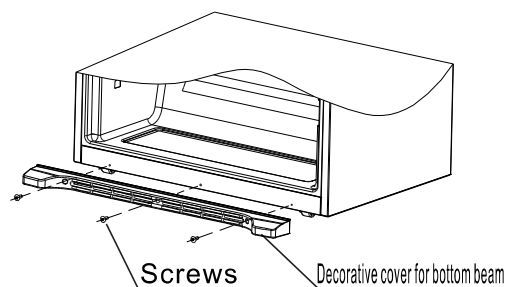

Cleaning the inside and outside of it by a wet cloth (a little abstergent can be added into the warm water, using clean water last)

A sole 2 pin-plug with earthing line is needful; do not share one electrical outlet with other appliance.

Earthing line is essential, electrical outlet should be with a intact earthing line.

Refrigerators transpo rtion and location

Transportion

Please don't inverted,squeezed, virbration refrigertor. when moving, the tilt angle can't larger than 45 degree.

When moving, dont cling the door or coping.

Location

Ensure proper air circulation around refrigerator , dont place the unit near heat source, direct sunlight , moisture or water, avoid rust and weakening the insulation.

Top space at least 30cm , space on both the sides and back at least 10cm from the wall, So refrigeratordoor can open or close convenience and emanate heat.

Installing the refrigerator on solid 、 level floor(If don't level ,it can adjust the leveler to level.)

Attention

Dont allow the power cable pressed by refrigerator or other heavy object ,lest damaging the power cable ,it may arouse suddenness.

Before connecting the power ,please checking the voltage range of refrigerator and power supply carefully.

Start using

Before it is used, make sure that the refrigerator is installed on the solid and level floor. .To understand all the attention to security matters.

1. After unsealing the refrigerator, to fix lower cover on the refrigerator.

(If the door rugged, Please refer to the adjustment instructions which locate in the lower left corner of the right panel of Refrigerator to adjust.)

2.Connect to power supply

After connecting to power supply, the refrigerator is in the default status,and it shows the actual chilled and frozen temperature . The refrigerator has a Power-down memory, The first time when it is power on, then every time will be set up at the last power-down operation.

3.Work model of the refrigerator

You can choose one of the following two models of refrigerators to set up.

(1) Intelligent mode: If there are not special needs,we recommend that you use the Intelligent mode,because the refrigerator will work automatically.

(2) Human mode: You can use Temperature Control keys to set the temperature.

4.Put the food into the refrigerator

After a period of time of the operation of electricity, the refrigerator inside is already

full cooling. Then you can put the food into the refrigerator and start using the refrigerator.

Tips: When the temperature is set to change or put new food into the refrigerator, it takes some time to balance the inside temperature. The length of this period depends on the size of the temperature change, the temperature of surrounding environment, the frequency of opening door and the number of food, and so on.

Refrigerator compartment

Put the food which are short-term storage or to eat at any time in the refrigerator compartment.

Although regulating temperature will enable average temperature of the majority of regional cold rooms maintain between 0-10 °C, it can not make long-term preservation of food. Therefore, refrigerator compartment only use as a short-term food storage.

Shelf adjustment

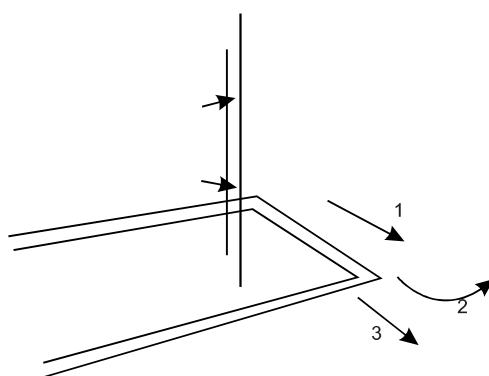

According to the needs of food storage, you can adjust the shelf to proper position; To facilitate the use of it or adjustment the location, the shelf can be set to slip so that you can use and adjust it easily. When you want to clear the shelf, please move the shelf by the direction (1), then turn the shelf in the direction (2) for 90° until it is perpendicular to the original direction, pull out the shelf by the direction (3).

Height adjustment and cleaning of rack

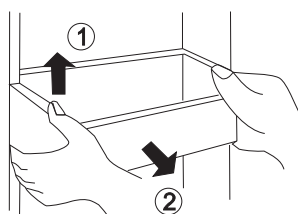

Lift the **rack** by the direction ①, hold both the sides, then pull it out by the direction ②. After cleaning, to install the **rack** by the opposite direction. You can also adjust the position according to the height of stored food.

Refrigerator compartment

Recommendations of storage area for all kinds of food

As the cycle of air-conditioning in the refrigerator, it makes the temperature of all area differences. So different kinds of food should be placed on different temperature region.

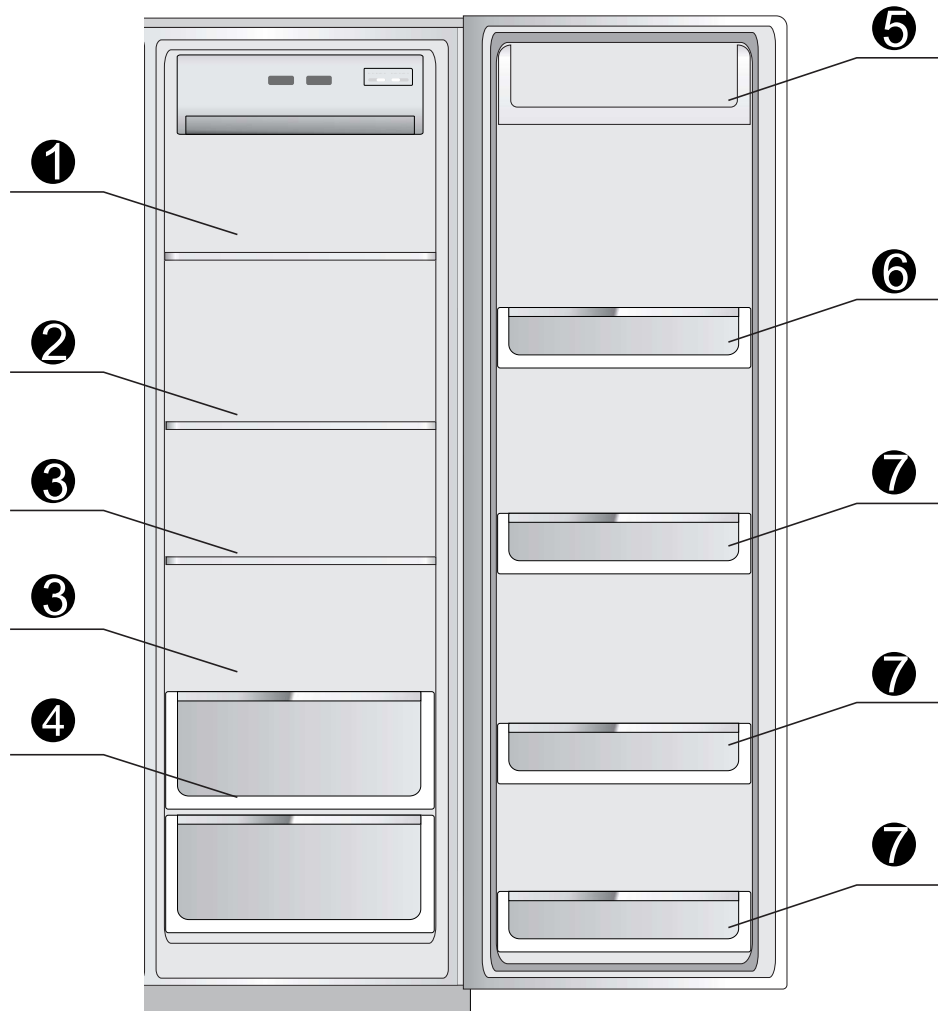

- ① Store pasta, canned ,milk, etc.
- ② Store fast food, easy-string together gustatorius food, dairy products, etc.
- ③ Store cooked meat and sausage, etc.
- ④ Store fruits and vegetables, etc
- ⑤ Store eggs, butter, cheese, etc.
- ⑥ Store easy-open tin can , canned, spices, etc.
- ⑦ Store all kinds of bottled drinks and food

Freezer compartment

Freezer compartment is for food storage for a long time

The temperature of freezer compartment is very low, so it can keep food fresh state for a long time. You'd better put the food which need long period of time to save in this space. But, you should comply with the storage time marked on food packaging.

Recommendations of storage area for all kinds of food

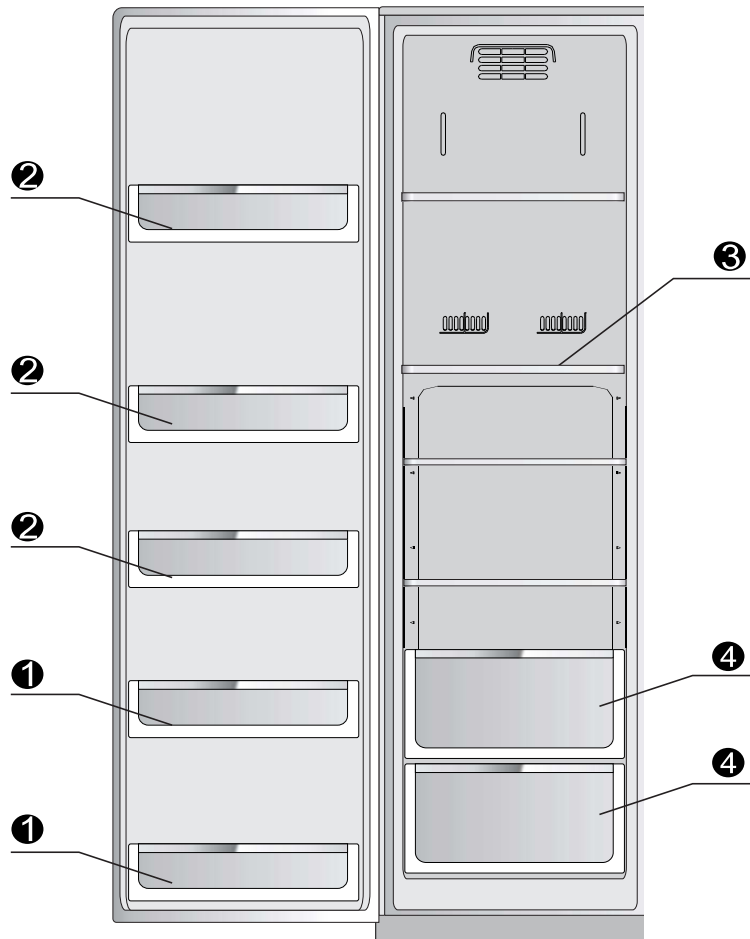

① The storage grilles on the door of the freezer room (2 stars) are used for short-term storage of food and ice cream.

② **The storage grilles in the freezer room are used for the storage of frozen food.**

③ The glass shelves are used for the storage of frozen foods, such as fish, meat and ice cream.

④ Freezer drawer is used for the storage of fish, meat and poultry with the food packaging.

Introduction of Function

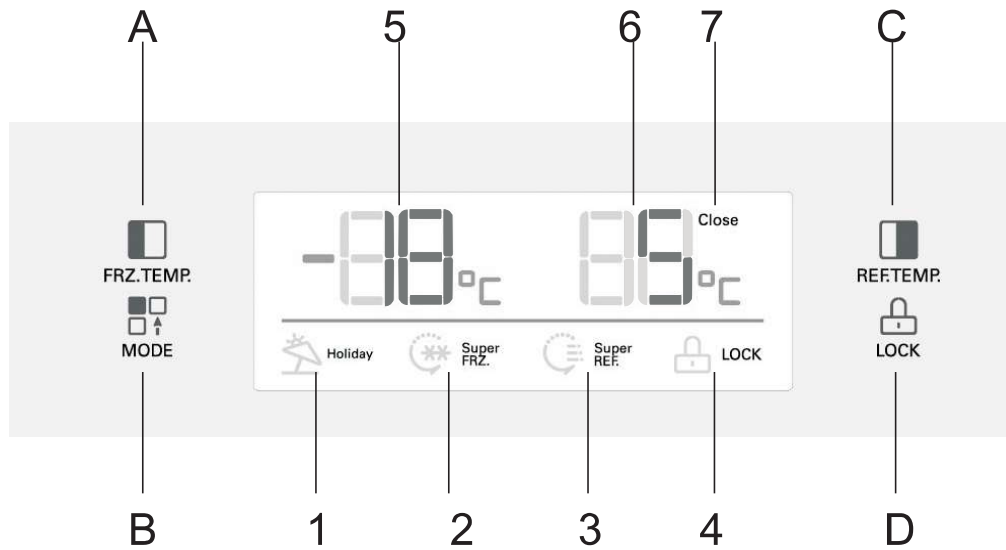

1. Button operation

- A.**Freezer compartment temperature adjustment **B.**Mode Settings
C.Refrigerator compartment temperature adjustment **D.**Lock/Unlock

2.Display

- 1.**Vocation mode **2.**Quick-freezer mode **3.**Quick-cold mode
4.Lock icon **5.**Freezer compartment temperature
6.Refrigerator compartment temperature **7.**Close icon

3.Lock/Unlock

At non-lock state(the 4 icon does not show),press D key,the refrigerator will go into the state of Locked and the 4 icon shows.
 Press D key for 3 seconds persistently at the Locked state, the 4 icon disappears and the Locked state releases.

The following functions must be in operation under the unlocked state

Press mode button (button B), you can choose running mode as the following.



4.Vocation mode

Press B key to select Vocation mode, the **1** icon shows ,then press D key to confirm, the refrigerator will be running according to Vocation mode.

5. Rapid cooling mode

Press B key to select Rapid cooling mode , the **3** icon shows, then press D key to confirm, the refrigerator will be running according to Rapid cooling mode.

6. Quick-freeze mode

Press B key to choose Quick-freeze mode, the **2** icon shows, then press D key to confirm, the refrigerator will be running according to Quick-freeze mode.

7. Refrigerator compartment temperature settings

Press C key once, the Refrigerator compartment temperature displays with flashing, press C key again and you can set the temperature , the range of temperature is from 2°C to 8°C

8. Freezer room temperature settings

Press A key once, the freezer room temperature displays with flashing, press D key again and you can set the temperature , the range of temperature is from -16°C to -24°C.

Note: when the set temperature of freezer changes, if set relevant function mode (e.g. quick-cold mode, quick-freezer mode, quick-cold and freezer mode, vacation mode), the relevant function mode should be quitted or canceled at once.

9. Shut down the refrigerator compartment

Push down C for three seconds , the buzzer sound , then the refrigerator compartment is shut down. When the refrigerator compartment closed , the **6** shows "--" , and the **7** icon is lighten.

When the refrigerator compartment is shut down, press **C** for three seconds again, the buzzer sound, then the refrigerator compartment running, and the **6** is normal display, the **7** is off.

Announcements

● the refrigerator use alternating current supply which is 220V-240V, 50Hz. If the voltage fluctuations is large (Over the scope of 187-264V), it may cause some failures, such as the refrigerator does not start, The main control board and compressor burn and the compressor works with abnormal voice. etc. At this time you must install an automatic voltage regulator which is above 1000W for use. The refrigerator power's cord with a three-plug (grounding) complies with the standard three-socket (grounding). Don't cut off or remove the third pin of the power cord under any circumstances. After the refrigerator is installed , Plugs should be able to reach to facilitate use. the power Plug must be firmly contacted with the socket, otherwise it might cause fire.

● Do not grasp and drag the power cord to pull out the refrigerator plugs. Hold the plug firmly , and pull out the plug from the socket directly . Do not let power lines be pinned by the refrigerator or trampled by people. Be careful when the refrigerator will be removed from walls. Do not roll or damage power lines, Do not use power lines and plugs When they were damaged or worn out. Go to the service center which the factory assigns to replace power lines if they were worn out or damaged.

● When inflammable gas is leaked, such as coal gas, close the gas valve, Open the doors and windows, Do not pull out or plug in plugs of the refrigerator and other appliances.

● Do not store explosive substances such as aerosol cans with a flammable propellant in this appliance.

● Do not use flammable solvent near refrigerator, so as to avoid fire.

● To ensure safety, do not place power outlets, voltage regulated power supply, microwave ovens and other appliances on refrigerator table. Do not use other appliances in refrigerator (except recommended models), In order to avoid electromagnetic interference and other accidents.

● Do not let children go into the refrigerator or climb up the refrigerator. In order to avoid the children are closed in it or the refrigerator falls to hurt children.

● After the refrigerator is running, Do not touch the icy surface of the freezer with hands, particularly hands are wet, It may cause frostbite.

● The gap between door and door and the gap between door and refrigerator body are very narrow. Be careful not to stretch hands into these areas to prevent fingers from injuring. Do not let the children near the refrigerator when open and close the doors.

● Do not spray and rinse the refrigerator with water, and do not install the refrigerator in the wet place or the place which water or rain splashes, so as not to affect the electrical insulation of the refrigerator.

● Never dismantle refrigerator personally, never transform refrigerator and damage cooling pipes. Maintenance of refrigerator must be carried out by professionals

● Do not put bottled beer, drinks in the freezer. It may freeze the contents to break the bottle.

● Pull out the plug when power failure or cleaning. Wait for 5 minutes or longer when reconnecting the plug. It may damage the compressor due to continuous start.

● Before you dispose your old refrigerator, take off the door, remove the door seals and the shelves, place the door and rack in the right position, so as to avoid the children climb inside to cause accidents.

● This product is for household refrigerator, according to the regulation of government standard, Household refrigerators are only for food storage, not for other uses, such as storage of blood, drugs and biological products.

Maintenance and care refrigerator

Defrost the freezer

The freezer compartment will defrost automatically, without manual

Cleaning

The remnants of food in the refrigerator will have bad odor, so it is necessary to clean the refrigerator regularly.

● For security, pull out the power plug before cleaning.

● Use soft towel or sponge with warm water to clean the refrigerator.

● Remove the water on the surface of refrigerator by a dry cloth.

Replacement on lights in freezer and refrigerator, and specification of lights

- Specification: direct current 12v, LED
- Shut off the power
- As per the photo, remove the shade along the drive direction of the arrow, and then tighten the screws, remove the LED lights;
- Restore, replace anti-steps
- Replaced by professionals

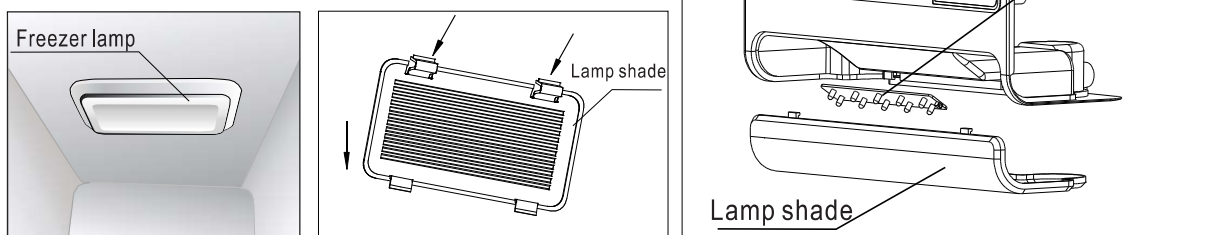

When Shutting off the refrigerator

No use for Long period of time

You Should pull out the power supply, otherwise, it may cause electric shock or fire if power lines are aging.

When Power failure

You Should minimize the frequency of opening the door, and it is not appropriate to add to fresh foods in the refrigerator.

When discarding the refrigerator

Before you throw away your old refrigerator, make sure take off the doors, so as to avoid the children climb inside to cause accidents.

Simple trouble analyzing and shooting

Please read the following contents carefully before repair request

Occurrence	Possible cause/inspection items
	Make sure power supply connecting and Plug is tightly put into outlet Check the voltage (too low), call local

not working	electrical company
not perfectly cooling	temperature be adjusted too high (make it lower) too much food stored hot or warm food stored recently doors are opened too frequently or too long heat source nearby
too much noise	plain floor or refrigerator be placed firmly check the appurtenance putting the right location
food be freezed	if it is laid near the wind way
Ordrs	smelling food should be packed rigorously corrupt food inner cabinet needs cleaning

If the situation seems not be better after the above items been checked, please contact our after-sale service. If the power cable is damaged, the repair must be done by the engineers sent by us for avoiding any danger..

Non-malfunction Phenomenon

The flowing speed of the refrigerant in the capillary is very high, sometime alveoli been intermixed. Hence some irregular noise may happen at the exit.

When humidity too high, surroundings of the refrigerator door may be a little wet, please wipe by a dry cloth.

Correct Disposal of this product	
	<p>Correct Disposal of this product</p> <p>This marking indicates that this product should not be disposed with other household wastes throughout the EU. To prevent possible harm to the environment or human health from uncontrolled waste disposal, recycle it responsibly to promote the sustainable reuse of material resources. To return your used device, please use the return and collection systems or contact the retailer where the product was purchased. They can take this product for environmental safe recycling.</p>

Energy Saving Tips

- The appliance should be located in the coolest area of the room, away from heat producing appliances or heating ducts, and out of the direct sunlight.
- Let hot foods cool to room temperature before placing in the appliance. Overloading the appliance forces the compressor to run longer. Foods that freeze too slowly may lose quality, or spoil.
- Be sure to wrap foods properly, and wipe containers dry before placing them in the appliance. This cuts down on frost build-up inside the appliance.
- Appliance storage bin should not be lined with aluminum foil, wax paper, or paper toweling. Liners interfere with cold air circulation, making the appliance less efficient.
- Organize and label food to reduce door openings and extended searches. Remove as many items as needed at one time, and close the door as soon as possible.