



Instruction Manual
Beverage Cooler

BDC46BLK
BDC76BLK

CONTENTS

1 Safety warnings

1.1 Warning	1-2
1.2 Meaning of safety warning symbols	3
1.3 Electricity related warnings	3
1.4 Related warnings for use	4
1.5 Warnings related to placing items	5
1.6 Warnings for energy	5
1.7 Warnings related to disposal	5

2 Proper use of the beverage cooler

2.1 Names of components	6
2.2 Temperature Control	7
2.3 Placement	7
2.4 Start to use	7
2.5 The arrangement of bottle	7
2.6 Usage of temperature zones inside the beverage cooler	7
2.7 Energy saving tips	7
2.8 Reversing the door swing	8-9

3 Maintenance of the beverage cooler

3.1 Do not use for a short time	10
3.2 Do not use for a long time	10
3.3 Clean the beverage cooler	10

4 Trouble shooting	11
--------------------	----

1 Safety warnings

1.1 Warning



Warning: risk of fire / flammable materials

This appliance is intended to be used in household and similar applications such as staff kitchen areas in shops, offices and other working environments; farm houses and by clients in hotels, motels and other residential type environments; bed and breakfast type environments; catering and similar non-retail applications.

This appliance is not intended for use by persons (including children) with reduced physical, sensory or mental capabilities, or lack of experience and knowledge, unless they have been given supervision or instruction concerning use of the appliance by a person responsible for their safety.)

Children should be supervised to ensure that they do not play with the appliance.

If the supply cord is damaged, it must be replaced by the manufacturer, its service agent or similarly qualified persons in order to avoid a hazard.

Do not store explosive substances such as aerosol cans with a flammable propellant in this appliance.

The appliance has to be unplugged after use and before carrying out user maintenance on the appliance.

Warning: Keep ventilation openings, in the appliance enclosure or in the built-in structure, clear of obstruction.

Warning: Do not use mechanical devices or other means to accelerate the defrosting process, other than those recommended by the manufacturer.

Warning: Do not damage the refrigerant circuit.

Warning: Do not use electrical appliances inside the food storage compartments of the appliance, unless they are of the type recommended by the manufacturer.

Warning: Please abandon the refrigerator according to local regulators for it use flammable blowing gas and refrigerant.

Warning: When positioning the appliance, ensure the supply cord is not trapped or damaged.

Warning: Do not locate multiple portable socket-outlets or portable power supplies at the rear of the appliance.

Do not use extension cords or ungrounded two prong adapters.

Danger: Risk of child entrapment. Before you throw away your old refrigerator or freezer:

- Take off the doors.
- Leave the shelves in place so that children may not easily climb inside.





The refrigerator must be disconnected from the source of electrical supply before attempting the installation of accessory.

Refrigerant and cyclopentane foaming material used for the appliance are flammable. Therefore, when the appliance is scrapped, it shall be kept away from any fire source and be recovered by a special recovering company with corresponding qualification other than be disposed by combustion, so as to prevent damage to the environment or any other harm.

The necessity that, for doors or lids fitted with locks and keys, the keys be kept out of the reach of children and not in the vicinity of the refrigerating appliance, in order to prevent children from being locked inside.

For EN standard: This appliance can be used by children aged from 8 years and above and persons with reduce physical sensory or mental capabilities or lack of experience and knowledge if they have been given supervision or instruction concerning use of the appliance in a safe way and understand the hazards involved. Children shall not play with the appliance. Cleaning and user maintenance shall not be made by children without supervision. Children aged from 3 to 8 years are allowed to load and unload refrigerating appliances.

To avoid contamination of food, please respect the following instructions:

- Opening the door for long periods can cause a significant increase of the temperature in the compartments of the appliance.
- Clean regularly surfaces that can come in contact with food and accessible drainage systems.
- Clean water tanks if they have not been used for 48 h; flush the water system connected to a water supply if water has not been drawn for 5 days. (note 1)
- Store raw meat and fish in suitable containers in the refrigerator, so that it is not in contact with or drip onto other food.
- Two-star  frozen-food compartments are suitable for storing pre-frozen food, storing or making ice-cream and making ice cubes. (note 2)
- One , two , three-star  -and four-star  compartments are not suitable for the freezing of fresh food. (note 3)
- For appliances without a 4-star compartment: this refrigerating appliance is not suitable for freezing foodstuffs. (note 4)
- If the refrigerating appliance is left empty for long periods, switch off, defrost, clean, dry, and leave the door open to prevent mould developing within the appliance.



Note 1,2,3,4: Please confirm whether it is applicable according to your product compartment type.

For a freestanding appliance: this refrigerating appliance is not intended to be used as a built-in appliance.

For wine storage appliances: this appliance is intended to be used exclusively for the storage of wine.

Any replacement or maintenance of the LED lamps is intended to be made by the manufacturer, its service agent or similar qualified person.

1.2 Meaning of safety warning symbols

	The symbols indicate prohibited matters, and those behaviors are forbidden. Non-compliance with the instructions may result in product damages or endanger the personal safety of users.
	The symbols indicate matters that must be followed, and those behaviors must be strictly executed in line with the operation requirements. Non-compliance with the instructions may result in product damages or endanger the personal safety of users.
	The symbols indicate matters to pay attention to, and these behaviors shall be specially noted. Due precautions are needed or minor or moderate injuries or damages of the product will be caused.

This manual contains lots of important safety information which shall be observed by the users.

1.3 Electricity related warnings

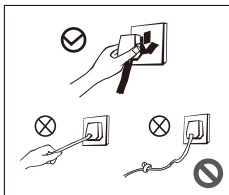

- Do not pull the power cord when pulling the power plug of the beverage cooler. Please firmly grasp the plug and pull out it from the socket directly.
- Do not damage the power cord under any condition so as to ensure safety use, do not use when the power cord is damaged or the plug is worn.
- Worn or damaged power cord shall be replaced in manufacturer-authorized maintenance stations.

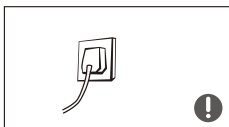

- The power cord should be firmly contacted with the socket or else fires might be caused. Please ensure that the grounding electrode of the power socket is equipped with a reliable grounding line.



- Please turn off the valve of the leaking gas and then open the doors and windows in case of leakage of gas and other flammable gases. Do not unplug the beverage cooler and other electrical appliances considering that spark may cause a fire.

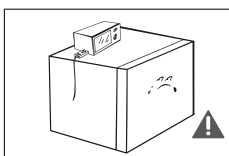

- To ensure safety, it is not recommended that to place socket, regulators, rice cookers, microwave ovens and other appliances at the top of the beverage cooler, those recommended by the manufacturer are not included. Do not use electrical appliances in the food pantry.

1.4 Related warnings for use

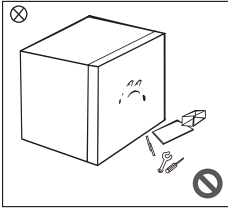

- Do not arbitrarily disassemble or reconstruct the beverage cooler, nor damage the refrigerant circuit; maintenance of the appliance must be conducted by a specialist.
- Damaged power cord must be replaced by the manufacturer, its maintenance department or related professionals in order to avoid danger.

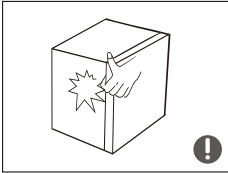

- The gaps between beverage cooler door and beverage cooler body are small, be noted not to put your hand in these areas to prevent from squeezing the finger. Please be gentle when close or open the beverage cooler door to avoid falling articles.

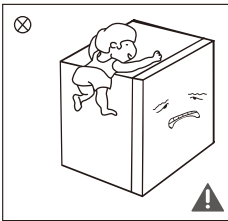

- Do not give package and other components to children to play. The bending board and plastic film may lead to suffocation! Do not allow children to enter or climb the beverage cooler to prevent that children are sealed in the beverage cooler or children are injured by the falling beverage cooler.
- Do not spray or wash the beverage cooler; do not put the beverage cooler in moist places easy to be splashed with water so as not to affect the electrical insulation properties of the beverage cooler.
- Do not use beverage cooler body, beverage cooler door, etc. as pedal or support.

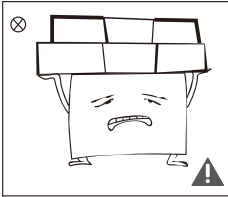

- Do not place heavy objects on the top of the beverage cooler considering that objects may fall when open or close the door, and accidental injuries might be caused.
- Please pull out of the plug in case of power failure or cleaning. Do not connect the beverage cooler to power supply within five minutes to prevent damages to the compressor due to successive starts.

1.5 Warnings related to placing items

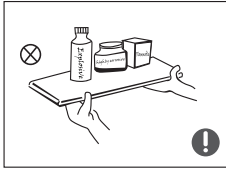

- Do not put flammable, explosive, volatile and highly corrosive items in the beverage cooler to prevent damages to the product or fire accidents.
- Do not place flammable items near the beverage cooler to avoid fires.

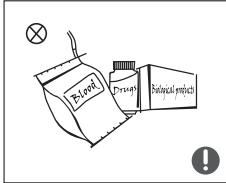

- This product is for household refrigeration appliances, mainly used in the storage of beverage, not for other purposes, such as storage of blood, drugs and biological products.

1.6 Warnings for energy

- 1) Beverage cooler might not operate consistently when sited for an extended period of time below the cold end of the range of temperatures for which the beverage cooler appliance is designed.
- 2) The need to not exceed the storage time(s) recommended by the beverage manufacturers for any kind of beverage.
- 3) The precautions necessary to prevent an undue rise in the temperature of the beverage while defrosting the beverage cooler.
- 4) The fact that a rise in temperature of the beverage during manual defrosting, maintenance or cleaning could shorten the storage life.

1.7 Warnings related to disposal



Refrigerant and cyclopentane foaming material used for the beverage cooler are flammable. Therefore, when the beverage cooler is scrapped, it shall be kept away from any fire source and be recovered by a special recovering company with corresponding qualification other than be disposed by combustion, so as to prevent damage to the environment or any other harm.



When the beverage cooler is scrapped, disassemble the doors, and remove gasket of door and shelves; put the doors and shelves in a proper place, so as to prevent trapping of any child.



Correct Disposal of this product :

This marking indicates that this product should not be disposed with other household wastes. To prevent possible harm to the environment or human health from uncontrolled waste disposal, recycle it responsibly to promote the sustainable reuse of material resources. To return your used device, please use the return and collection systems or contact the retailer where the product was purchased. They can take this product for environmental safe recycling.

2 Proper use of the beverage cooler

2.1 Names of components

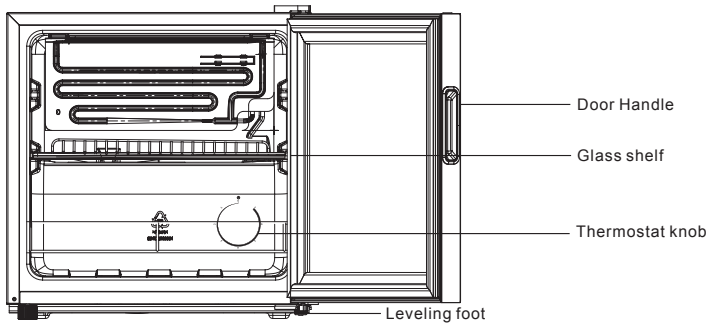

BDC46BLK

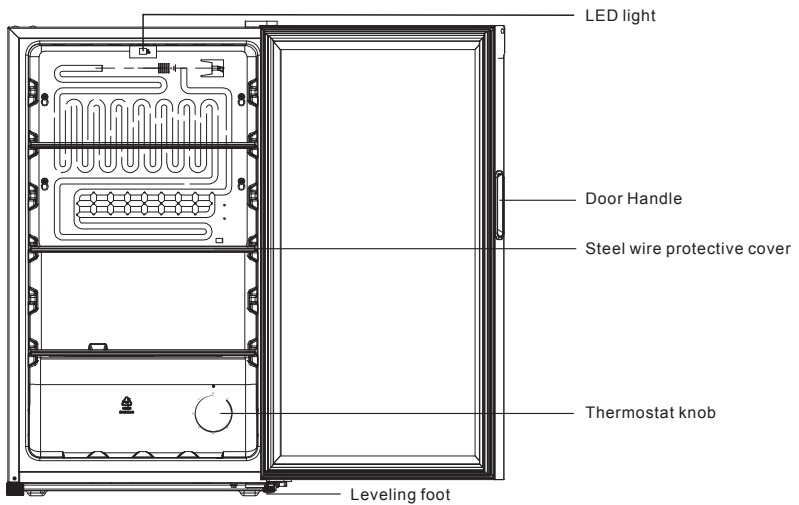

BDC76BLK

(The picture above is only for reference. The actual configuration will depend on the physical product or statement by the distributor)

- Shelf in accordance with the factory state placed the most energy – saving.
There is no need to turn on the light when working normally.
- The beverage cooler is mainly used for storing drinks.
Do not place food in the beverage cooler to prevent bacterial contamination.
- Please keep the interior of the beverage cooler dry.

2.2 Temperature Control

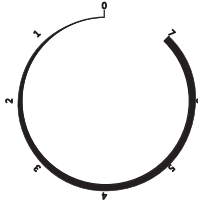

(The picture above is only for reference. The actual configuration will depend on the physical product or statement by the distributor)

Setting "1" warmest setting (ie 15degrees approx when ambient temperature is at 25 degree for reference)

Setting "7" coldest setting (ie 2degrees approx when ambient temperature is at 25 degree for reference)

2.3 Placement

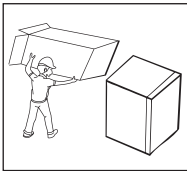

- Before using the beverage cooler, remove all packaging materials including bottom cushions and foam pads and tapes inside the beverage cooler. tear off the protective film on the door and the beverage cooler body.

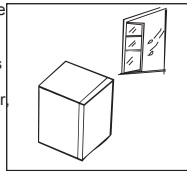

- The beverage cooler is placed in a well-ventilated indoor place; the ground shall be flat, and sturdy (rotate left or right to adjust the leg for levelling if unstable).

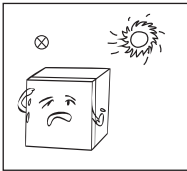

- Avoid direct sunlight and heat sources such as stove, heating radiator, etc. If the beverage cooler has to be put next to heat source, a suitable insulation board shall be applied or keep the beverage cooler away from heat source.

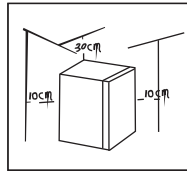

- The top space of the beverage cooler shall be greater than 30cm, and the distances from both sides and backside shall be more than 10cm to facilitate heat dissipation.

2.4 Start to use

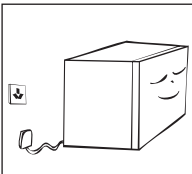

- The beverage cooler shall stay for half an hour before connecting power when it is firstly started.
- Clean up the inner chamber before put into use for first time .
- Do not connect beverage cooler to electronic energy saving plug and converter that can convert DC into AC (E.g.: solar energy system, ship grid).
- Water drop or frost will be generated on backside of beverage cooler when compressor is running, which is decided by function of beverage cooler. wiping out frost or water drop is not needed as the back will wipe them out automatically. The defrosted water will be collected into drain tank, then inflow into water disposal pan above the compressor and vaporized.

2.5 The arrangement of bottle

Do not let bottle touch the beverage cooler's back in order to maintain good air circulation in the beverage cooler. The bottle number may be different from bottles in different shape and size. Oversized bottle may have impact on the number of bottle storage in the beverage cabinet.

2.6 Usage of temperature zones inside the beverage cooler

Due to different temperature zones generated due to air circulation in the cooler, the upper area's temperature is higher than the lower area.

2.7 Energy saving tips

- The beverage cooler shall be placed in room dry and ventilated. The beverage cooler be put under direct sunlight or next to heat source (such as radiator, stove, etc.) and a suitable insulation board shall be applied if necessary.
- Try to shorten opening time of beverage cooler's door.
- Put beverage into beverage cooler after it has cooled down.

2.8 Reversing the door swing

1. Change the installation location of the upper hinge^⑤ of the beverage cabinet, then the opening direction of the door could be changed at will. Please follow the following instructions for the change of the opening direction of the beverage cabinet's door (for instance: from right-handed door to left-handed door): close the glass door of the beverage cabinet, use a blade to remove the rivet^② carefully, loose the mounting cover^③ of the door hinge and three positioning bolts^④ and remove the upper hinge^⑤.

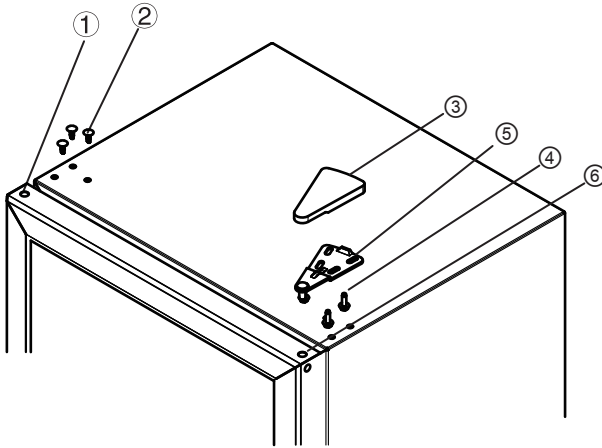

2. Open the door of the beverage cabinet and detach the glass door of which with tremendous care.

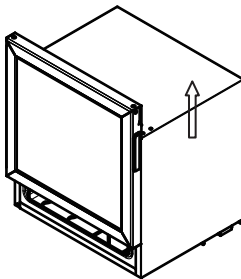

3. Dismantle the door axle sleeve⑥at lower part of the glass door, door stopper block screws⑧and door stopper⑦, and fix them to left side.

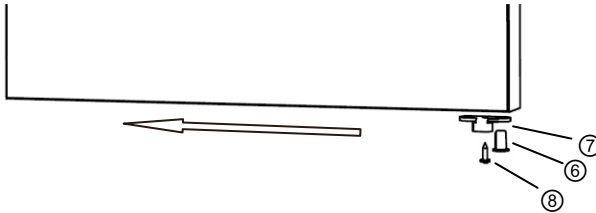

4. Dismantle the adjustable foot⑪, positioning bolts④and lower hinge⑩, then exchange the parts of right and left sides and later use the reverse method to install the adjustable foot, lower hinge and positioning bolts.

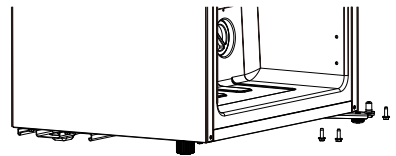
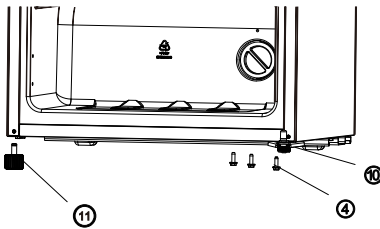

5. Put the aforesaid glass door on the lower hinge⑤, and fix the upper hinge⑤. Align the door with the cabinet and check the tightness of gasket, and then install all the ornaments②③.

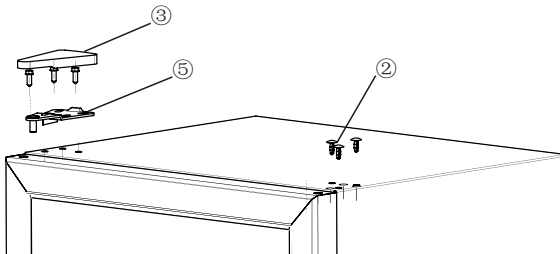

(The picture above is only for reference. The actual configuration will depend on the physical product or statement by the distributor)

3 Maintenance of the beverage cooler

3.1 Do not use for a short time

Switch gears to OFF, or disconnect the power

3.2 Do not use for a long time

- 1 Disconnect power plug;
- 2 Clean the beverage cooler;
- 3 Keep the beverage cooler door open.

3.3 Clean the beverage cooler

- Dusts behind the beverage cooler and on the ground shall be timely cleaned to improve the cooling effect and energy saving.
- Check the door gasket regularly to make sure there are no debris. Clean the door gasket with a soft cloth dampened with soapy water or diluted detergent.
- The interior of the beverage cooler should be cleaned regularly to avoid odor. Please turn off the power before cleaning interior, remove all foods, drinks, shelves, etc.
- Use a soft cloth or sponge to clean the inside of the beverage cooler, with two tablespoons of baking soda and a quart of warm water. Then rinse with water and wipe clean. After cleaning, open the door and let it dry naturally before turning on the power.
- For areas that are difficult to clean in the beverage cooler (such as narrow sandwiches, gaps or corners), it is recommended to wipe them regularly with a soft rag, softbrush, etc. and when necessary, combined with some auxiliary tools (such as thin sticks) to ensure no contaminants or bacterial accumulation in these areas.
- Do not use soap, detergent, scrub powder, spray cleaner, etc., as these may cause odors in the interior of the beverage cooler or contaminated food.
- Clean the shelves with a soft cloth dampened with soapy water or diluted detergent. Then rinse with water and dry with a soft cloth or dry naturally.
- Wipe the outer surface of the beverage cooler with a soft cloth dampened with soapy water, detergent, etc., and then wipe dry. Do not rub or scratch the surface of the glass door to prevent the door from being broken or scratched.
- Do not use hard brushes, clean steel balls, wire brushes, abrasives (such as toothpastes), organic solvents (such as alcohol, acetone, banana oil, etc.), boiling water, acid or alkaline items, which may damage the beverage cooler surface and interior. Boiling water and organic solvents such as benzene may deform or damage plastic parts.
- Do not rinse directly with water or other liquids during cleaning to avoid short circuits or affect electrical insulation after immersion.



Notice :

Do not use detergent and solvent with sand or acid.

4 Trouble shooting

Inoperation	Whether the beverage cooler is plugged and connected to power; Low voltage; Whether temperature control knob is in the work area; Failure power or tripping circuit.
Long-term operation of compressor	It is normal that beverage cooler operates for longer time in summer when the ambient temperature is higher; Do not put too much beverage s in the beverage cooler at one time; Frequent opening of beverage cooler door.
Illuminating light does not shine	Whether the beverage cooler is connected to power, whether the indicator light is damaged.
Loud noises	Whether the floor is flat, whether the placement of beverage cooler is stable; Whether the beverage cooler accessories are properly placed.
beverage cooler enclosure heat Condensation	The beverage cooler enclosure may emit heat during running specially in summer, this is caused by the radiation of the condenser, and it is a normal phenomenon. Condensation: condensation phenomenon will be detected on the exterior surface and door seals of the beverage cooler when the ambient humidity is high, this is a normal phenomenon, and after wiping with towel, turns up the set temperature of the beverage cooler properly.
Airflow sound Buzz Clatter	Refrigerants circulating in the refrigerant lines will produce eruption of sound and grunts which is normal does not affect the cooling effect. Buzz will be generated by running compressor specially when starting up or shutting down.

Belling Customer Care

Please keep this handbook in a safe place. Please fill in the model number and serial number in the spaces provided below as they will assist us should you need to call.

01 8428288

When you dial this number you will hear a recorded message and be given a number of options. This indicates that your call has been accepted and is being held in a queue. Calls are answered in strict rotation as our Customer Care Representatives become available.

Enter appliance number here for future reference. These numbers can be found on your appliances.

Model No. _____
Serial No. _____



Glen Dimplex Ireland

Airport Road, Cloghran, Co. Dublin

Web: www.glendimplexireland.com

Email: serviceireland@glendimplex.com

sparesireland@glendimplex.com

salesireland@glendimplex.com