

# **TOSHIBA**

**43LL2C63DB**

## **QUICK START GUIDE**

Please visit [www.toshiba-tv.com](http://www.toshiba-tv.com) to download the full user manual.



## 1 Building and fitting stand

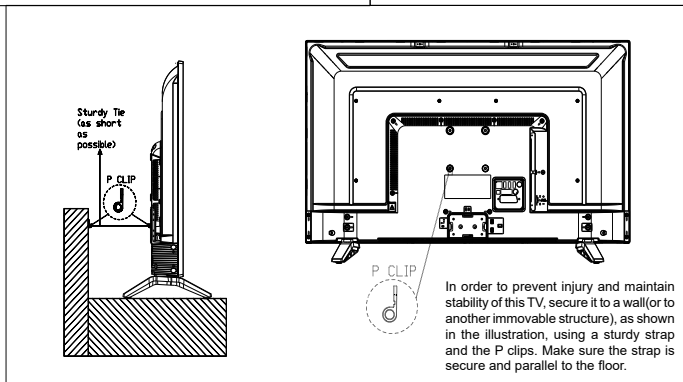
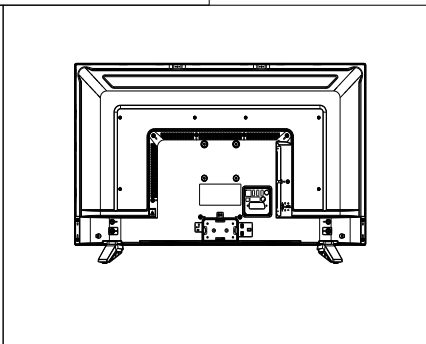
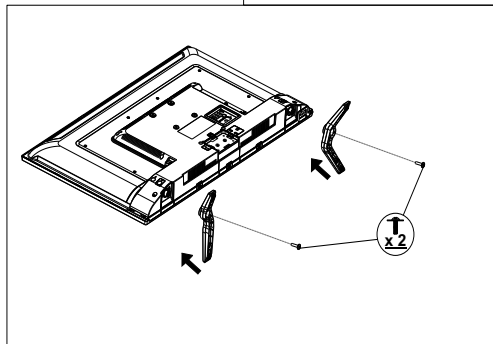
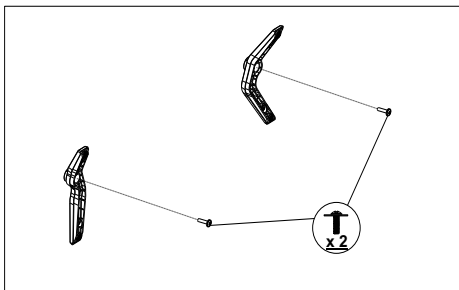

## 2 Inserting the batteries into the remote

Remove the back cover to reveal the battery compartment. Insert two 1.5V size **AAA** batteries. Make sure the (+) and (-) signs match (observe correct polarity). Do not mix old and new batteries. Replace only with same or equivalent type. Place the cover back on. A message will be displayed on the screen when the batteries are low and must be replaced.

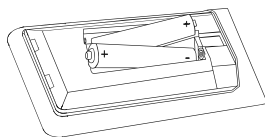

## 3 Connections

### Antenna

Connect the antenna cable/s to your TV.

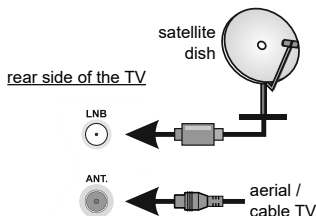

### HDMI connection

rear side or rear-left side of TV



### Power

After unpacking, allow the TV set to reach the ambient room temperature before you connect the set to the mains. Plug one end (the two-hole plug) of the supplied detachable power cord into the power cord inlet on the rear side of the TV. Then plug the other end of the power cord into the mains socket outlet.

Plug the power cord to the mains socket whilst in 'off' position, and then turn the mains socket on.

**IMPORTANT:** The TV set is designed to operate on a **220-240V AC, 50 Hz** supply.

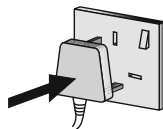

## 4 Switching on the TV

In order to turn the TV on from standby mode:

- Press the **Standby** button, a numeric button, **Programme +/-** button, **Guide** button, **Netflix** button or **Freeview Play** button on the remote control
- Press the control button on the TV

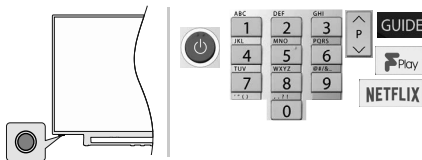

## 5 Internet connection

You can set up your TV so that it can access the Internet through your local area network (LAN) using a wired or wireless connection. Refer to full user manual for detailed instructions.

### Wired

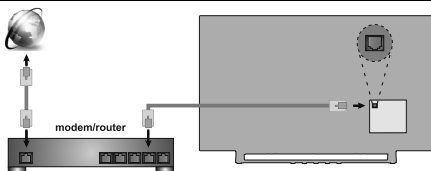

### Wireless

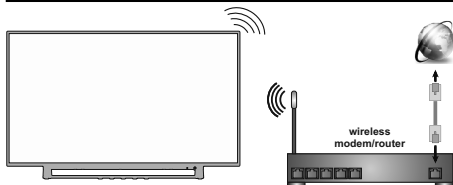

**Note:** The figures are for representation only

### External Devices



**PLEASE ENSURE BOTH UNITS ARE SWITCHED OFF BEFORE CONNECTING**

Use the proper cable to connect two units together.

To select the desired input source, press the **Source** button on the remote control. Or press the control button to display the function options menu and then press the button consecutively to move the focus to **Source** option. Press and hold the button for about 2 seconds to activate this option. The icon colour of the option changes when activated. Then press the button once again to display the **Sources list**. Scroll through the available sources by pressing the button.

## 6 Remote control

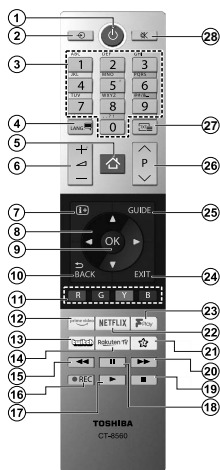

1. Standby
2. Source
3. Numeric buttons
4. Language
5. Menu
6. Volume +/-
7. Info
8. Directional buttons
9. OK
10. Back/Return
11. Coloured Buttons
12. Prime Video
13. Twitch
14. Rakuten TV
15. Rewind
16. Record
17. Play
18. Pause
19. Stop
20. Fast Forward
21. My Button 1
22. Netflix
23. Freeview Play
24. Exit
25. Guide
26. Programme +/-
27. Text
28. Mute

## 7 First time installation

When turned on for the first time, the TV's welcome screen will be displayed. Select your language and press **OK**. Follow the on screen instructions to setup your TV and install channels. The installation wizard will guide you through the setup process. You can perform **First Time Installation** anytime using the related option in the **Settings>Installation** menu.

## 8 Accessing E-Manual and the full user manual

You can find instructions for your TV's features in the E-Manual. To use E-Manual, enter **Settings** menu, select **Manuals** and press **OK**. For quick access to E-Manual press **Menu**  button and then **Info**  button.

You can also review your TV's full user manual online or download as you like. Scan this QR code or visit <https://toshiba-tv.com>



If you like to register your Toshiba TV, please visit the Toshiba support website as per link above and select "Register".

## Accessories Included

- Remote Control
- Batteries: 2 x AAA
- Quick Start Guide
- P-clip x2
- Stand x2
- Screw x2

## Feature Overview

### Media Browser

Browse the media content stored on USB devices that are connected to your TV

### Common Interface

Decode encrypted digital TV channels with a Conditional Access Module(CAM) and a card provided by a digital TV service operator

### USB Recording

Record your favourite TV and radio programmes

### Electronic Programme Guide

Display the scheduled digital TV and radio programmes

### CEC

Control basic functions of the connected HDMI-CEC compatible audio/video devices with the remote control of the TV

### Audio Video Sharing

Access your media files stored on media server devices, such as PC's or handheld devices, that are connected to your home network

### HbbTV

Access to HbbTV services (services are dependant on broadcast)

### Apps

Access the applications installed on your TV, add more from the market

### Open Browser

Browse the internet from the comfort of your sofa

### Wireless Display

Wirelessly stream video and sound content and use your TV as a second screen for your compatible PC or handheld device

### Smart Center

Use the **Smart Center** application installed on your mobile device to launch your applications, control your TV, share media files and stream TV programmes. Scan this QR code to download the app



### Virtual Remote

Control your TV via a wireless handheld device

### Bluetooth®

Connect audio devices or remote controllers wirelessly to your TV.



Some features may not be available, dependant on your TV model. Please check the product fiche for the product specifications relating to your model

For more detailed information and videos on installation, function and features of your TV, refer to the full manual on our website:  
<http://toshiba-tv.com/uk-uk/support>

## High Dynamic Range (HDR) / Hybrid Log-Gamma (HLG)

Using this feature the TV can reproduce greater dynamic range of luminosity by capturing and then combining several different exposures. HDR/HLG promises better picture quality thanks to brighter, more realistic highlights, more realistic colour and other improvements. It delivers the look that filmmakers intended to achieve, showing the hidden areas of dark shadows and sunlight with full clarity, colour and detail. HDR/HLG contents are supported via native and market applications, HDMI, USB inputs and over DVB-S broadcasts.

## Safety Information

	<b>CAUTION</b> RISK OF ELECTRIC SHOCK DO NOT OPEN	
<b>CAUTION:</b> TO REDUCE THE RISK OF ELECTRIC SHOCK DO NOT REMOVE COVER (OR BACK). NO USER-SERVICEABLE PARTS INSIDE. REFER SERVICING TO QUALIFIED SERVICE PERSONNEL.		

In extreme weather (storms, lightning) and long inactivity periods (going on holiday) disconnect the TV set from the mains.

The mains plug is used to disconnect TV set from the mains and therefore it must remain readily operable. If the TV set is not disconnected electrically from the mains, the device will still draw power for all situations even if the TV is in standby mode or switched off.

**Note:** Follow the on screen instructions for operating the related features.

### IMPORTANT - Please read these instructions fully before installing or operating

**WARNING:** This device is intended to be used by persons (including children) who are capable / experienced of operating such a device unsupervised, unless they have been given supervision or instruction concerning the use of the device by a person responsible for their safety.

- Use this TV set at an altitude of less than 5000 metres above the sea level, in dry locations and in regions with moderate or tropical climates.
- The TV set is intended for household and similar indoor use but may also be used in public places.
- For ventilation purposes, leave at least 5cm of free space around the TV.
- The ventilation should not be impeded by covering or blocking the ventilation openings with items, such as newspapers, table-cloths, curtains, etc.
- The power cord/plug should be easily accessible. Do not place the TV, furniture, etc. on the power cord. A damaged power cord/plug can cause fire or give you an electric shock. Handle the power cord by the plug, do not unplug the TV by pulling the power cord. Never touch the power cord/plug with wet hands as this could cause a short circuit or electric shock. Never make a knot in the power cord or tie it with other cords. When damaged it must be replaced, this should only be done by qualified personnel.
- Do not expose the TV to dripping or splashing of liquids and do not place objects filled with liquids, such as vases, cups, etc. on or over the TV (e.g. on shelves above the unit).
- Do not expose the TV to direct sunlight or do not place open flames such as lit candles on the top of or near the TV.





- Do not place any heat sources such as electric heaters, radiators, etc. near the TV set.
- Do not place the TV on the floor and inclined surfaces.
- To avoid danger of suffocation, keep plastic bags out of the reach of babies, children and domestic animals.
- Carefully attach the stand to the TV. If the stand is provided with screws, tighten the screws firmly to prevent the TV from tilting. Do not over-tighten the screws and mount the stand rubbers properly.
- Do not dispose of the batteries in fire or with hazardous or flammable materials.

### WARNING

- Batteries must not be exposed to excessive heat such as sunshine, fire or the like.
- Excessive sound pressure from earphones or headphones can cause hearing loss.

**ABOVE ALL - NEVER let anyone, especially children, push or hit the screen, push anything into holes, slots or any other openings in the case.**

 Caution	Serious injury or death risk
 Risk of electric shock	Dangerous voltage risk
 Maintenance	Important maintenance component

### Markings on the Product

The following symbols are used on the product as a marker for restrictions and precautions and safety instructions. Each explanation shall be considered where the product bears related marking only. Note such information for security reasons.



**Class II Equipment:** This appliance is designed in such a way that it does not require a safety connection to electrical earth.



**Hazardous Live Terminal:** The marked terminal(s) is/are hazardous live under normal operating conditions.



**Caution, See Operating Instructions:** The marked area(s) contain(s) user replaceable coin or button cell batteries.



**Class 1 Laser Product:** This product contains Class 1 laser source that is safe under reasonably foreseeable conditions of operation.

## WARNING

Do not ingest the battery, Chemical Burn Hazard. This product or the accessories supplied with the product may contain a coin/button cell battery. If the coin/button cell battery is swallowed, it can cause severe internal burns in just 2 hours and can lead to death.

Keep new and used batteries away from children. If the battery compartment does not close securely, stop using the product and keep it away from children.

If you think batteries might have been swallowed or placed inside any part of the body, seek immediate medical attention.

-----

A television may fall, causing serious personal injury or death. Many injuries, particularly to children, can be avoided by taking simple precautions such as:

- ALWAYS use cabinets or stands or mounting methods recommended by the manufacturer of the television set.
- ALWAYS use furniture that can safely support the television set.
- ALWAYS ensure the television set is not overhanging the edge of the supporting furniture.
- ALWAYS educate children about the dangers of climbing on furniture to reach the television set or its controls.
- ALWAYS route cords and cables connected to your television so they cannot be tripped over, pulled or grabbed.
- NEVER place a television set in an unstable location.
- NEVER place the television set on tall furniture (for example, cupboards or bookcases) without anchoring both the furniture and the television set to a suitable support.
- NEVER place the television set on cloth or other materials that may be located between the television set and supporting furniture.
- NEVER place items that might tempt children to climb, such as toys and remote controls, on the top of the television or furniture on which the television is placed.
- The equipment is only suitable for mounting at heights  $\leq 2$  m.

If the existing television set is going to be retained and relocated, the same considerations as above should be applied.

-----

Apparatus connected to the protective earthing of the building installation through the MAINS connection or through other apparatus with a connection to protective earthing – and to a television distribution system using coaxial cable, may in some circumstances create a fire hazard. Connection to a television distribution system has therefore to be provided through a device providing electrical isolation below a certain frequency range (galvanic isolator).

Using the special functions to change the size of the displayed image (i.e. changing the height/width ratio) for the purposes of public display or commercial gain may infringe on copyright laws.

The LCD display panels are manufactured using an extremely high level of precision technology; however, sometimes some parts of the screen may be missing picture elements or have luminous spots. This is not a sign of a malfunction.

## Mains Supply

The set should be operated only from a 220-240 V AC 50 Hz outlet. Make sure the TV or its stand are not placed on the power cord. DO NOT cut off the mains plug from this equipment, this incorporates a special Radio Interference Filter, the removal of which will impair its performance. In the UK, the fuse fitted in this plug is approved by ASTA or BSI to BS1362. It should only be replaced by a correctly rated and approved type. IF IN DOUBT PLEASE CONSULT A COMPETENT ELECTRICIAN.

## WALL MOUNTING WARNINGS

- Read the instructions before mounting your TV on the wall.
- The wall mount kit is optional. You can obtain from your local dealer, if not supplied with your TV.
- Do not install the TV on a ceiling or on an inclined wall.
- Use the specified wall mounting screws and other accessories.
- Tighten the wall mounting screws firmly to prevent the TV from fall. Do not over-tighten the screws.

Figures and illustrations in this user manual are provided for reference only and may differ from the actual product appearance. Product design and specifications may be changed without notice.

## Licence Notification

The terms HDMI, HDMI High-Definition Multimedia Interface, HDMI trade dress and the HDMI Logos are trademarks or registered trademarks of HDMI Licensing Administrator, Inc.



Manufactured under licence from Dolby Laboratories. Dolby, Dolby Audio, and the double-D symbol are trademarks of Dolby Laboratories Licensing Corporation.



YouTube and the YouTube logo are trademarks of Google Inc.

For DTS patents, see <http://patents.dts.com>. Manufactured under licence from DTS Licensing Limited. DTS, DTS-HD, Virtual:X, and the DTS-HD logo are registered trademarks or trademarks of DTS,



The *Bluetooth*<sup>®</sup> word mark and logos are registered trademarks owned by the Bluetooth SIG, Inc. and any use of such marks by Vestel Elektronik Sanayi ve Ticaret A.S. is under licence. Other trademarks and trade names are those of their respective owners.

DVB is a registered trademark of the DVB Project.

[1] EIA/CEA-861-D compliance covers the transmission of uncompressed digital video with high-bandwidth digital content protection, which is being standardized for reception of high-definition video signals. Because this is an evolving technology, it is possible that some devices may not operate properly with the television.

This product contains technology subject to certain intellectual property rights of Microsoft. Use or distribution of this technology outside of this product is prohibited without the appropriate licence(s) from Microsoft.

Content owners use Microsoft PlayReady™ content access technology to protect their intellectual property, including copyrighted content. This device uses PlayReady technology to access PlayReady-protected content and/or WMDRM-protected content. If the device fails to properly enforce restrictions on content usage, content owners may require Microsoft to revoke the device's ability to consume PlayReady-protected content. Revocation should not affect unprotected content or content protected by other content access technologies. Content owners may require you to upgrade PlayReady to access their content. If you decline an upgrade, you will not be able to access content that requires the upgrade.

The "CI Plus" Logo is a trademark of CI Plus LLP.

This product is protected by certain intellectual property rights of Microsoft Corporation. Use or distribution of such technology outside of this product is prohibited without a licence from Microsoft or an authorised Microsoft subsidiary.

### Wireless LAN Transmitter Specifications

Frequency Ranges	Max Output Power
2400 - 2483.5 MHz (CH1 - CH13)	< 100 mW
5150 - 5250 MHz (CH36 - CH48)	< 200 mW
5250 - 5350 MHz (CH52 - CH64)	< 200 mW
5470 - 5725 MHz (CH100 - CH140)	< 200 mW

### Country Restrictions

The Wireless LAN equipment is intended for home and office use in the UK and Northern Ireland (and other countries following the relevant EU and/or UK

directive). The 5.15 - 5.35 GHz band is restricted to indoor operations only in the EU countries, in the UK and Northern Ireland.

Country	Restriction
Bulgaria	General authorisation required for outdoor use and public service
Italy	If used outside of its own premises, general authorisation is required. Public use is subject to general authorisation by the respective service provider
Greece	In-door use only for 5470 MHz to 5725 MHz band
Luxembourg	General authorisation required for network and service supply (not for spectrum)
Norway	Radio transmission is prohibited for the geographical area within a radius of 20 km from the centre of Ny-Alesund
Russian Federation	In-door use only
Israel	5 GHz band only for 5180 MHz-5320 MHz range

The requirements for any country may change at any time. It's recommended that user checks with local authorities for the current status of their national regulations for 5 GHz wireless LAN's.

### Specification

TV Broadcasting	PAL BG/IDK SECAM BG/DK
Receiving Channels	VHF (BAND I/III) - UHF (BAND U) - HYPERBAND
Digital Reception	Fully integrated digital terrestrial-cable-satellite TV (DVB-T-C-S) (DVB-T2, DVB-S2 compliant)
Number of Preset Channels	11000
Channel Indicator	On Screen Display
RF Aerial Input	75 Ohm (unbalanced)
Operating Voltage	220-240V AC, 50Hz.
Audio	DTS Virtual:X DTS-HD
Audio Output Power (WRMS.) (10% THD)	2x8
Power Consumption (W)	75 W
Networked Standby Mode Power Consumption (W)	< 2
Weight (kg)	7.5
TV Dimensions DxLxH (with foot) (mm)	234 x 973 x 620
TV Dimensions DxLxH (without foot) (mm)	81 x 973 x 567
Display	16:9 43"
Operation temperature and operation humidity	0°C up to 40°C, 85% humidity max

## Disposal...

The following information is only for EU-member states:

### Disposal of products

The crossed out wheeled dust bin symbol indicates that products must be collected and disposed of separately from household waste. Integrated batteries and accumulators can be disposed of with the product. They will be separated at the recycling centres.



The black bar indicates that the product was placed on the market after August 13, 2005.

By participating in separate collection of products and batteries, you will help to assure the proper disposal of products and batteries and thus help to prevent potential negative consequences for the environment and human health.

For more detailed information about the collection and recycling programmes available in your country, please contact your local city office or the shop where you purchased the product.

### Disposal of batteries and/or accumulators

The crossed out wheeled dust bin symbol indicates that batteries and/or accumulators must be collected and disposed of separately from household waste.



If the battery or accumulator contains more than the specified values of lead (Pb), mercury (Hg), and/or cadmium (Cd) defined in the European Battery Directive, then the chemical symbols for lead (Pb), mercury (Hg) and/or cadmium (Cd) will appear below the crossed out wheeled dust bin symbol.

By participating in separate collection of batteries, you will help to assure the proper disposal of products and batteries and thus help to prevent potential negative consequences for the environment and human health. For more detailed information about the collection and recycling programmes available in your country, please contact your local city office or the shop where you purchased the product.

## REACH information

The European Union (EU) chemical regulation, REACH (Registration, Evaluation, Authorisation and Restriction of Chemicals), entered into force on 1 June 2007.

Toshiba will meet all REACH requirements and is committed to provide our customers with information about the presence in our articles of substances included on the candidate list according to REACH regulation.

Please consult the following website [www.toshiba-tv.com](http://www.toshiba-tv.com) for information about the presence in our articles of substances included on the candidate list according to REACH in a concentration above 0.1 % weight by weight.

## EU Conformity Statement



This product is carrying the CE and UKCA marks in accordance with the related European Directives and UK Directives.

Responsible for CE and UKCA marking is Vestel UK, Langley, Berkshire, SL3 6EZ.

This product is labelled with the CE and UKCA marks in accordance with the related European Directives and UK Directives, notably 2015/863/EU RoHS Directive and The Restriction of the Use of Certain Hazardous Substances in Electrical and Electronic Equipment Regulations 2012 for UK. Furthermore the product complies with the Ecodesign Directive 2005/32/EC (EuP), 2009/125/EC (ErP), The Ecodesign for Energy-Related Products and Energy Information Regulations 2021 for UK and its related implementing measures.

This equipment corresponds to requirements of the Technical Regulation on limitation of usage of certain dangerous substances in electrical and electronic equipment.

Find out all you need to know about the latest, trend-setting TV technology on our website.

[www.toshiba-tv.com](http://www.toshiba-tv.com)

You can download the full manual, watch support videos, learn latest FAQs, stick your head into the forum, or register your TV in the support section.

Hereby, VESTEL Elektronik Sanayi ve Ticaret A.Ş., declares that the radio equipment type TV is in compliance with Directive 2014/53/EU. The full text of the EU declaration of conformity is available at the following internet address: [doc.vosshub.com](http://doc.vosshub.com)

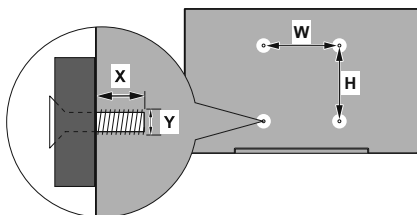

### VESA WALL MOUNT MEASUREMENTS

Hole Pattern Sizes (mm)	W	H
	100	100
Screw Sizes		
Length (X)	min. (mm)	7
	max. (mm)	8
Thread (Y)	M4	





50656886