

# 说明书递交文档

设计 DESIGN	程磊 2016.02.18	图纸名称 PART NAME  BFF295SS CE-BCD308WE-S 52003081000G  英语说明书				图号/物料编码 PART NO.
校对 CO. BY	黄志胜					16131000A07022
标准化 STANDARD						材料 MATERIAL  80g双胶纸
业务 seller	许岩	图样 标记 REL	版本号 REV. NO .	重量 (g)	比例 scale	
批准 AUTHORIZE	曾磊		0		1:1	美的冰箱事业部 MIDEA REFRIGERATION DIVISION
		共 页 TOTAL SHEETS	第 页 NO. OF SHEETS			

## 技术要求

- 1、 尺寸：145\*210mm。
- 2、 油墨颜色为黑色:黑白印刷，印刷应清晰，不能有印刷缺陷。
- 3、 切边应成直角，不能歪斜。
- 4、 样板需送设计部门认可方可生产。

标记 MARKER	变更内容	修改日期	签名
1	封面增加客户型号，自XXXXXXX开始更新	2016.03.09	程磊



**Instruction Manual**  
**Refrigerator-Freezer**

**MODEL: BFF295SS**  
**BFF295BK**



# Contents

---

<b>Safety Warnings</b> .....	4
<b>Unpacking</b> .....	6
<b>Installation</b> .....	7
Location .....	7
Levelling the Unit .....	7
Free Space Requirements .....	7
Reversing the Door Swing.....	8
Cleaning Before Use .....	10
Before Using Your Unit.....	10
Door Handle Installation .....	10
<b>Product Overview</b> .....	11
<b>Operation</b> .....	12
Switching On Your Unit .....	12
Adjusting the Temperature.....	12
Noises Inside the Unit!.....	13
Tips for Keeping Food in the Unit.....	13
Preparations for Freezing.....	14
Defrosting Frozen Food.....	14
<b>Cleaning</b> .....	15
Defrosting .....	15
Cleaning the Interior and the Exterior of the Unit.....	15
<b>Maintenance</b> .....	16
Changing the Internal Light .....	16
Care When Handling / Moving the Unit.....	16
Servicing.....	16
Switching Off for Long Periods of Time .....	16
Condensation.....	16
<b>Disposal</b> .....	16

## Safety Warnings

---

For your continued safety and to reduce the risk of injury or electric shock, please follow all the safety precautions listed below.

- Read all instructions carefully before using the unit and keep them for future reference.
- Retain the manual. If you pass the unit onto a third party, make sure to include this manual.
- This appliance is intended for use in Domestic situations only and should not be used in commercial or other business applications.  
It should be used in a dry indoor location not subject to sub-zero temperatures.
- Ensure that the plug is easily accessible to enable disconnection from the mains supply.
- If the mains cable is damaged, it must be replaced by the manufacturer, its service agent or a qualified technician in order to avoid a hazard.
- Choose a location for your unit away from heat sources such as radiators for fires as refrigerant and vesicant are flammable.
- The unit must be manoeuvred by a minimum of 2 persons.
- This appliance can be used by children aged from 8 years and above and persons with reduced physical, sensory or mental capabilities or lack of experience and knowledge if they have been given supervision or instruction concerning use of the appliance in a safe way and understand the hazards involved. Children shall not play with the appliance. Cleaning and user maintenance shall not be made by children without supervision.
- Children should be supervised to ensure that they do not play with the unit.
- If your unit is fitted with a lock to prevent children being trapped inside, keep the key out of reach and not in the vicinity of the unit.
- Do not store explosive substances such as aerosol cans with a flammable propellant in this appliance.

- Do not store bottles or glass containers in the freezer compartment. Contents can expand when frozen (fizzy drinks) which may break the bottle and damage your freezer compartment. (If applicable)



### **WARNING**

- Keep ventilation openings in the unit enclosure or in the built-in structure clear of obstructions.
- Do not use mechanical devices or other means to accelerate the defrosting process, other than those recommended by the manufacturer.
- Do not use electrical appliances inside the food storage compartments of the unit, unless they are of the type recommended by the manufacturer.
- Do not damage the refrigerant circuit (The refrigerant is a very environmental-friendly gas but is also combustible. Take care when transporting or moving the unit to ensure that the refrigeration circuit is not damaged. In the event of damage avoid naked flames or ignition sources and ventilate the room in which the unit is placed for a few minutes.)

### **WARNING**



IT IS HAZARDOUS FOR ANYONE OTHER THAN AUTHORISED SERVICE PERSONNEL TO CARRY OUT SERVICING OF REPAIRS WHICH INVOLVE THE REMOVAL OF COVERS.



TO AVOID THE RISK OF AN ELECTRICAL SHOCK DO NOT ATTEMPT REPAIRS YOURSELF.

**Thank you** for purchasing your new Belling Fridge Freezer.

We recommend that you spend some time reading this instruction manual in order that you fully understand all the operational features it offers.

Read all the safety instructions carefully before use and keep this instruction manual for future reference.

## Unpacking

Remove all items from the packaging. Retain the packaging. If you dispose of it please do so according to local regulations.

The following items are included:

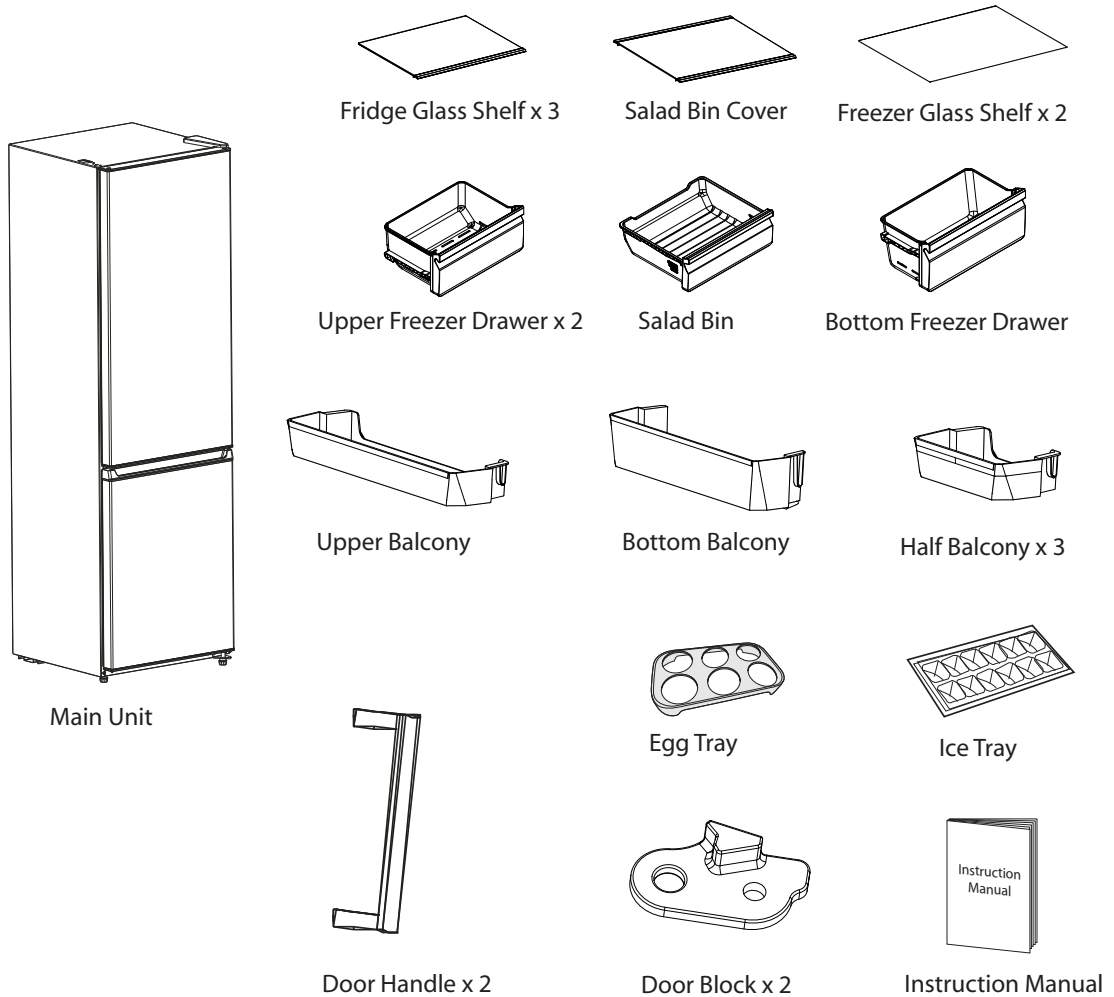

## INSTALLATION

### Location

When selecting a position for your unit you should make sure the floor is flat and firm, and the room is well ventilated with an average room temperature of between 16°C and 43°C. Avoid locating your unit near a heat source, e.g. cooker, boiler or radiator. Also avoid direct sunlight as it may increase the electrical consumption. Extreme cold ambient temperatures may also cause the unit not to perform properly. This unit is not designed for use in a garage or outdoor installation. Do not drape the unit with any covering.

### Levelling the Unit

To do this adjust the two levelling feet at the front of the unit. If the unit is not level, the doors and magnetic seal alignments will not be covered properly.

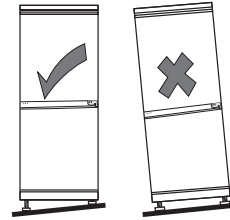

### Free Space Requirements

When installing the unit, ensure that 25 mm of free space is left at both sides, 50 mm at the rear and 25 mm at the top of the unit. The door can be opened to the right or the left, depending on what better suits the location.

Please ensure there is more than twice the width and depth distance space of the unit to fully open the door to a maximum angle of 160°.

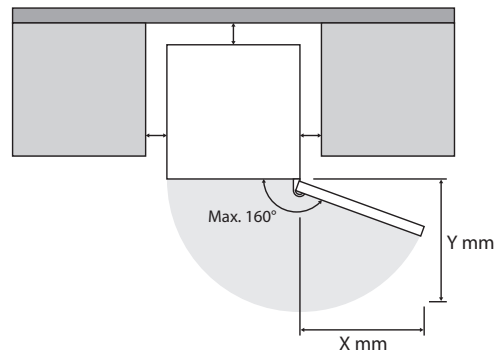

## INSTALLATION

### Reversing the Door Swing

**Tools required:** Philips style screwdriver / Flat bladed screwdriver / Hexagonal spanner



- Ensure the unit is unplugged and empty.
- All parts removed must be saved to do the reinstallation of the door.
- Do not lay the unit flat as this may damage the coolant system.
- We recommend that 2 people handle the unit during assembly.
- If you want to have the door swing reversed, we recommend that you contact a qualified technician. You should only try to reverse the door yourself if you believe that you are qualified to do so.

1. Take off the hinge cover.

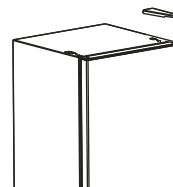

2. Remove the the upper hinge. Lift the upper door and place it on a padded surface to prevent it from scratching.

Remove the door block, screw and plastic tube under the upper door and move them to the opposite side. You may need to replace the door block to fit the opposite side.

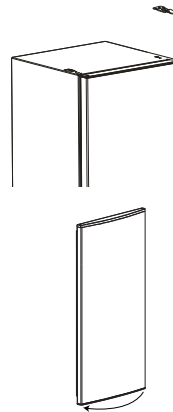

3. Take off the middle hinge by removing the screws. Lift the lower door and place it on a padded surface to prevent it from scratching.

Remove the screws' covers and place them to the opposite side.

Swap the position of the plastic tube and hole cover on top of the lower door.

Remove the door block, screw and plastic tube under the lower door and move them to the opposite side. You may need to replace the door block to fit the opposite side.

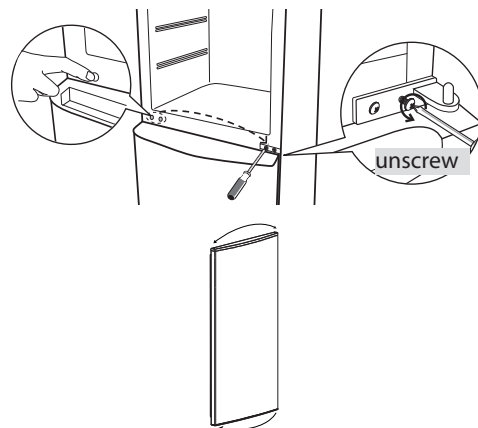

## INSTALLATION

4. Remove the lower screws and lower hinge from the unit bottom. Reverse the lower hinge, move and secure it with the lower screws to the opposite side of the unit bottom. Carefully set the lower door back into place, inserting it onto the lower hinge.

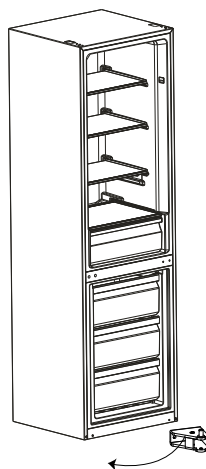

5. Reverse the middle hinge. Screw the middle hinge onto the opposite side of the unit.



Ensure the lower door is aligned horizontally and vertically, so that the seals are closed on all sides before finally tightening the hinge.

Middle hinge

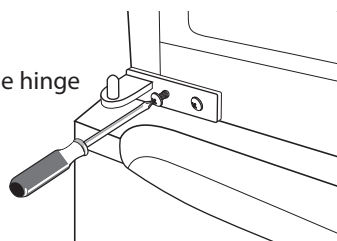

6. Carefully set the upper door back into place, inserting in onto the middle hinge.
7. Insert the upper hinge and screw it tightly to the top of the unit.



Ensure the upper door is aligned horizontally and vertically, so that the seals are closed on all sides before finally tightening the hinge.

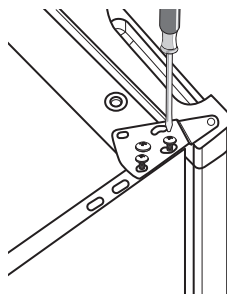

8. Put the hinge cover back.

## INSTALLATION

### Cleaning Before Use

Wipe the inside of the unit with a weak solution of bicarbonate soda. Then rinse with warm water using a sponge or cloth. Wipe completely dry before replacing the shelves, drawers and salad bin. Clean the exterior of the unit with a damp cloth.

If you require more information refer to the **Cleaning** section.



- **Before Plugging in YOU MUST**

Check that you have a socket which is compatible with the plug supplied with the unit.

- **Before Turning On!**

Do not turn on until two hours after moving the unit. The coolant fluid needs time to settle.

### Before Using Your Unit

Before placing any food in your unit, turn it on and wait for 24 hours, to make sure it is working properly and to allow it time to fall to the correct temperature. Your unit should not be overfilled.

### Door handle installation

1. Remove the plastic screw hole caps on the side of the door you require the handle to be installed with a flat headed screw driver. You must ensure that the screw hole caps are unscrewed and not pulled out or flicked out with a screw driver. Otherwise the screw part of the screw hole caps will break and become stuck.
2. Align the holes on the handle with those on the side of the door and fix it into place with the metal screw provided.
3. Cover the holes on the handle with the plastic hole caps.

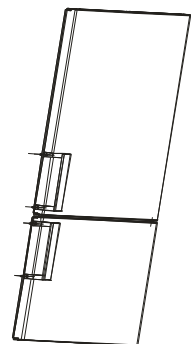
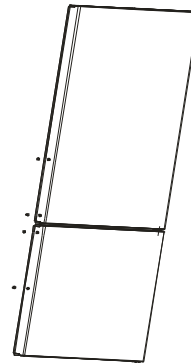

# Product Overview

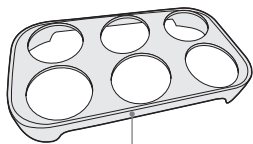
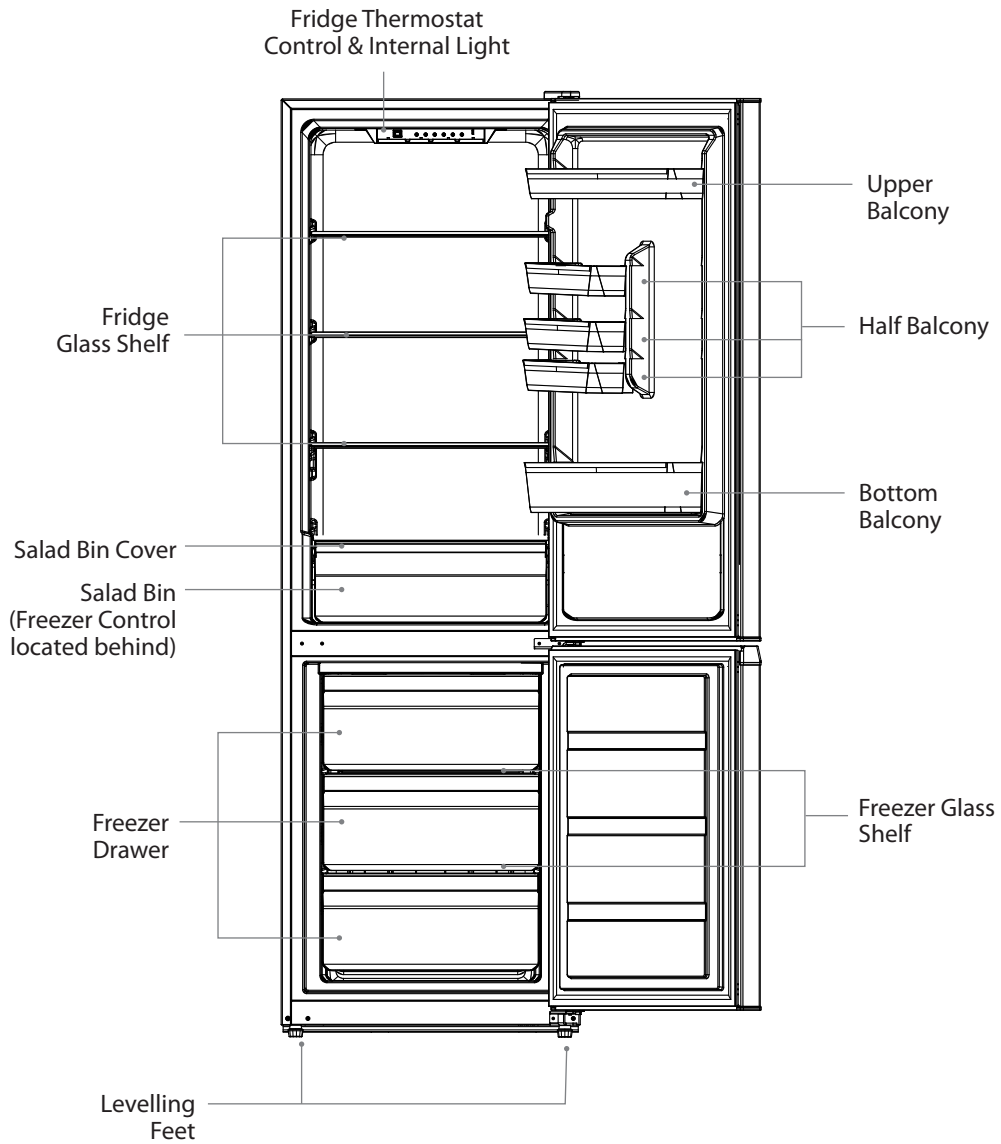

Egg Tray

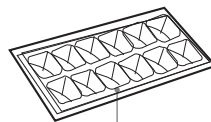

Ice Tray

## Operation

### Switching On Your Unit

- Connect the mains cable to the mains socket.
- The internal temperature of your fridge compartment is controlled by the Fridge Thermostat Control while the internal temperature of the freezer compartment is controlled by the Freezer Control (located behind the Salad Bin).
- The unit may not operate at the correct temperature if it is in a particularly hot or a particularly cold room, or if you open the doors often.
- To ensure that the unit is cool enough to sufficiently chill and freeze your food, wait 24 hours before filling it with food.
- If you are concerned that your unit is not being kept cold enough and wish to check the temperature, you will need a special fridge/freezer thermometer. These are available from most supermarkets and hardware shops. Place the thermometer in the centre of either the fridge or freezer compartment and leave overnight. The correct temperature for the fridge compartment should be an average of 5°C. The correct temperature for the freezer compartment should be -18°C or lower.

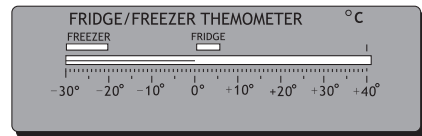

### Adjusting the Temperature

#### • Adjusting the temperature in the fridge compartment

There are six settings, of which position **2c** is the coldest and position **FAST COOL** turns the unit cold rapidly.

Press **SET TEMPERATURE** repeatedly to the desired position. Position **4c** is the recommended setting when operating at normal room temperature.

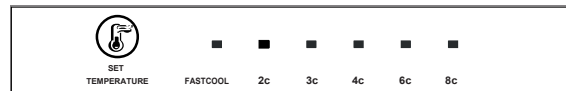

The recommended position is between **6c** to **8c** for colder working environments and between **2c** to **4c** for hotter environments. Please adjust according to the environment.

#### • Adjusting the temperature in the freezer compartment

There are three settings, of which position **COLDER** is the coldest.

Turn the control dial to the desired position. Position **NORMAL** is the recommended setting when operating at normal room temperature.

The recommended position is between **NORMAL** and **COLD** for colder working environments and between **NORMAL** and **COLDEST** for hotter environments. Please adjust according to the environment.

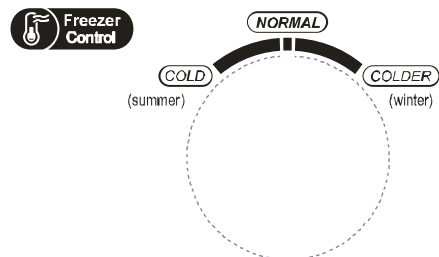

## Noises Inside the Unit!

You may notice that your unit makes some unusual noises. Most of these are perfectly normal, but you should be aware of them!

These noises are caused by the circulation of the refrigerant liquid in the cooling system. It has become more pronounced since the introduction of CFC free gases. This is not a fault and will not affect the performance of your unit. This is the compressor motor working, as it pumps the refrigerant around the system.

## Tips for Keeping Food in the Unit

- Cooked meats/fishes should always be stored on a shelf above raw meats/fishes to avoid bacterial transfer. Keep raw meats/fishes in a container which is large enough to collect juices and cover it properly. Place the container on the lowest shelf.
- Leave space around your food, to allow air to circulate inside the unit. Ensure all parts of the unit are kept cool.
- To prevent transfer of flavours and drying out, pack or cover the food separately. Fruit and vegetables do not need to be wrapped.
- Always let pre-cooked food cool down before you put in the unit. This will help to maintain the internal temperature of the unit.
- To prevent cold air escaping from the unit, try to limit the number of times you open the door. We recommend that you only open the door when you need to put food in or take food out.

## Preparations for Freezing

- Use quality food and handle it as little as possible. Freeze food in small quantities as it freezes faster, takes less time to defrost and enables you to control the quantity you need better.
- Leave cooked food to cool completely. Chill food before freezing if possible.
- Consider how you will want to cook the food before freezing it.
- Don't freeze food in metal containers if you may want to microwave it straight from the freezer.
- Use special freezer bags, freezer film, polythene bags, plastic containers, and aluminium foil (heavy duty grade only). If in doubt, double wrap your food. Don't use aluminium foil for acidic foods, e.g. citrus fruits. Don't use thin cling film, glass, or used food containers without cleaning.
- Exclude as much air from the container as possible. You could buy a special vacuum pump which sucks excessive air out of the packaging.
- Leave a small amount of air space when freezing liquids to allow expansion.
- You can use the space in the freezer most efficiently if you freeze liquids (or solids with liquids, e.g. stew) in square blocks. This is known as "Preforming". Pour the liquid into a polythene bag which is inside a square sided container. Freeze it, and then remove it from the container and seal the bag.
- Label your frozen foods as they will look the same when in frozen state. Use special freezer tapes, labels and pens with different colours. This allows you to easily organise and to effectively use the freezer. Write the contents and date; otherwise the frozen food might exceed the storage time and this could cause food poisoning. Please refer to your food packaging for the recommended storage time.
- You may also add the weight and cooking notes, e.g. "defrost first", "cook from frozen" and keep a separate log of what is in each drawer. This will save opening the door and searching around unnecessarily.

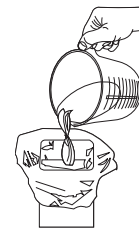

## Defrosting Frozen Food

1. Take the frozen food out from the unit and uncover the frozen food. Let it defrost at room temperature. Don't forget that defrosting in a warm area encourages the growth of bacteria and low temperature cooking may not destroy dangerous bacteria.
2. Drain off and throw away any liquid lost during defrosting.
3. Always make sure there are no ice-crystals in the food before cooking, particularly with meat. These crystals indicate that the food has not fully defrosted.
4. Cook food as soon as possible after defrosting.
5. Many microwaves and ovens have a defrost setting. To avoid bacterial build up, only use these if you intend to cook the food immediately afterwards.



Never re-freeze anything that has been defrosted unless you cook it again, to kill off harmful bacteria. Never re-freeze defrosted shellfish. Re-seal packs properly after removing items. This prevents drying or freezer-burn and a build up of frost on any remaining food.

## Cleaning

---

### Defrosting

The freezer compartment of this unit is frost-free. With proper use, there should not be any frost accumulated.

However, in case of improper use of the freezer compartment, frost might build up in the freezer compartment after the unit has been used for a period of time. Scrape away the frost using a plastic scraper (not included).



Do not use a metal or sharp instrument to scrape away the frost, nor should you use any electrical appliances to aid defrosting.

We recommend that defrosting should be carried out when the frost layer builds up to 3mm. Choose a time when the stock of frozen food is low, follow these procedures:

1. Take out the food, turn the unit off at the mains supply and leave the door open. Ideally, the frozen food should be put into another freezer. If this is not possible, wrap the food in several sheets of newspaper or large towels and then a thick rug or blanket to keep it cool.
2. Place a dry towel on the edge of the compartment shelf. Scrape away the frost using a plastic scraper. Defrosting the remaining frost can be speeded up by placing a bowl of hot water inside the freezer compartment and closing the door. As the solid frost loosens, scrape it away with the plastic scraper.
3. When defrosting is complete, clean your unit's interior and exterior.

### Cleaning the Interior and the Exterior of the Unit

- Remove all the shelves and drawers.
- Wipe the inside of the unit with a weak solution of bicarbonate soda and then rinse with warm water using a sponge or cloth. Wipe completely dry before replacing the shelves and drawers.
- Use a damp cloth to clean the exterior, and then wipe with a standard furniture polish. Make sure that the door is closed to avoid the polish getting on the magnetic door seal or inside the unit.
- The grille of the condenser at the back of the unit and the adjacent components can be vacuumed using a soft brush attachment.

## Maintenance

---

### **Changing the Internal Light**

The internal light is an LED light. It cannot be changed by the user; please contact your service agent.

### **Care When Handling / Moving the Unit**

Hold the unit around its sides or base when moving it.

### **Servicing**

The unit should be serviced by an authorised engineer and only genuine spare parts should be used. Under no circumstances should you attempt to repair the unit yourself. Repairs carried out by inexperienced persons may cause injury or serious malfunction. Contact a qualified technician.

### **Switching Off for Long Periods of Time**

When the unit is not in use for a long period of time, disconnect it from the mains supply, empty all food and clean the unit, leaving the door ajar to prevent unpleasant smells.

### **Condensation**

Condensation may appear on the outside of the unit. This may be due to a change in room temperature. Wipe off any moisture residue. If the problem continues, please contact a qualified technician for assistance.

## Disposal

---

Old units still have some residual value. An environmentally friendly method of disposal will ensure that valuable raw materials can be recovered and used again. The refrigerant used in the unit and insulation materials require special disposal procedures. Ensure that none of the pipes on the back of the unit are damaged prior to disposal.

Up to date information concerning options of disposing of your old unit and packaging from the new one can be obtained from your local council office.

When disposing of an old unit break off any old locks or latches and remove the doors as a safeguard.







# BELLING CUSTOMER CARE

---

In case of difficulty within the Republic of Ireland, please call Belling Customer Care Centre Helpline on:

**Phone 01 8428222**

**Fax 01 8428091**

When you dial this number you will hear a recorded message and be given a number of options.

This indicates that your call has been accepted and is being held in a queue. Calls are answered in strict rotation as our Customer Care Representatives become available.

Enter appliance numbers here for future reference:

Model No							
<input type="text"/>	<input type="text"/>	<input type="text"/>	<input type="text"/>	<input type="text"/>	<input type="text"/>	<input type="text"/>	<input type="text"/>
Serial No							
<input type="text"/>	<input type="text"/>	<input type="text"/>	<input type="text"/>	<input type="text"/>	<input type="text"/>	<input type="text"/>	<input type="text"/>

Please ensure you have the above details (Model No and Serial No) to hand when calling Belling Customer Care. They are essential to booking your call.

Service email: [service@dimpco.ie](mailto:service@dimpco.ie)

Spares email: [spares@dimpco.ie](mailto:spares@dimpco.ie)

Website for consumables: [www.dimpco.ie](http://www.dimpco.ie)

Hours of business: 9am - 1pm & 2pm - 5pm Monday - Friday

